

**THE AUSTRALIAN PIPE BAND
CONTEST REGULATION 2019**

of

PIPE BANDS AUSTRALIA INC (A00353465)

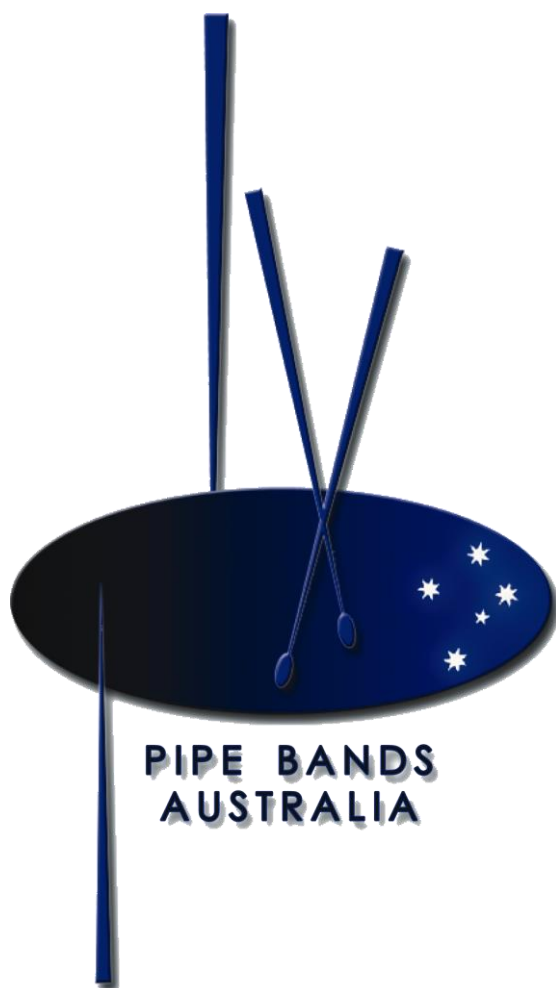

TO TAKE EFFECT ON
1 September 2019

HYPERLINK NAVIGATION

This document has hyperlinks from the table of contents to the relevant heading in the document.

To seek:

- Click the required item in the table of contents to go to that item in the document.

To return:

- Right-click on the document page and select the option to return to the previous view.

PIPE BANDS AUSTRALIA INC.

THE AUSTRALIAN PIPE BAND CONTEST REGULATION 2019

Contents

NOTE:	7
PART A - GENERAL.....	8
CHAPTER 1 - RULES OF GENERAL APPLICATION	8
A.1.01 TITLE AND CITATION	8
A.1.02 DEFINITIONS.....	8
A.1.03 APPLICATION OF THESE RULES	8
A.1.04 PENALTIES	8
A.1.05 PROTESTS	9
A.1.06 OFFICIALS	10
A.1.07 JUDGES	11
A.1.08 BEHAVIOUR	12
A.1.09 ADJUDICATION COMMITTEE.....	12
A.1.10 COMPLAINTS ABOUT ADJUDICATION	13
A.1.11 AMENDMENT OF THESE RULES	14
A.1.12 BRANCHES.....	14
A.1.13 TRIAL RULES	14
CHAPTER 2 - GRADING OF BANDS	15
A.2.01 GRADES	15
A.2.02 REVIEW OF GRADING	15
A.2.03 JUVENILE BANDS	17
CHAPTER 3 - REGISTRATION OF BANDS AND THEIR PLAYERS	18
A.3.01 REGISTRATION OF PLAYERS	18
A.3.02 CLEARANCES.....	18
A.3.03 MULTIPLE BANDS	18
A.3.04 ANNUAL REGISTRATION OF BANDS AND THEIR PLAYERS	19
A.3.05 CONTEST ENTRIES FROM REGISTERED BANDS ONLY	19
A.3.06 TUTORS	19
A.3.07 DUAL REGISTRATION.....	20
PART B - BAND CONTESTS.....	21
CHAPTER 1 - APPLICABLE TO ALL BAND CONTESTS.....	21
B.1.01 CONTESTS.....	21

B.1.02	COMPLEMENT.....	21
B.1.03	SUBSTITUTES.....	22
B.1.04	UNIFORM.....	22
B.1.05	DRAW.....	22
B.1.06	ATTENDANCE AND LATENESS.....	23
B.1.07	CONTACT BETWEEN JUDGES AND PLAYERS.....	23
B.1.08	JUDGING SHEETS.....	24
B.1.09	TIES.....	24
B.1.10	OFFICIALS.....	24
B.1.11	JUDGES.....	25
B.1.12	DRUM MAJOR.....	26
B.1.13	BAND FORMATION.....	26
B.1.14	JUDGING.....	26
B.1.15	MOVEMENT OF BANDS.....	27
B.1.16	AUSTRALIAN PIPE BAND CHAMPIONSHIPS.....	27
CHAPTER 2 - THE QUICKSTEP.....		29
B.2.01	MUSIC.....	29
B.2.02	POINTS ALLOTTED.....	29
B.2.03	JUDGING.....	29
B.2.04	COURSE AND MOVEMENTS.....	29
	Front to Rear, Flank to Flank Countermarch.....	30
	Box Wheels.....	31
	Gate Wheel.....	31
B.2.05	NO JUVENILE QUICKSTEP.....	31
CHAPTER 2A – THE LIMITED AREA QUICKSTEP.....		32
B.2A.01	MUSIC.....	32
B.2A.02	POINTS ALLOTTED.....	32
B.2A.03	JUDGING.....	32
B.2A.04	COURSE AND MOVEMENTS.....	32
CHAPTER 3 - THE MARCH STRATHSPEY & REEL/SELECTION OF MARCHES.....		34
B.3.01	MUSIC.....	34
B.3.02	POINTS ALLOTTED.....	34
B.3.03	PROCEDURE.....	35
B.3.04	WHEN ON STAGE OR DAIS.....	35
CHAPTER 4 - THE MEDLEY.....		37
B.4.01	MUSIC.....	37
B.4.02	POINTS ALLOTTED.....	37
B.4.03	PROCEDURE.....	37

B.4.04	PROCEDURE OPEN / CONCERT FORMATION	38
B.4.05	WHEN ON STAGE OR DAIS	38
CHAPTER 5	- THE DISPLAY	40
B.5.01	THE DISPLAY	40
B.5.02	THE DISPLAY - FORMAT	40
B.5.03	POINTS ALLOTTED	40
B.5.04	PROCEDURE	40
CHAPTER 6	- THE DRESS INSPECTION	41
B.6.01	WHEN TO BE CONDUCTED	41
B.6.02	DRESS INSPECTION DURING CONTEST ELEMENT	41
B.6.03	DRESS INSPECTION AFTER CONTEST ELEMENT	41
B.6.04	POINTS ALLOTTED	41
CHAPTER 7	- THE STREET MARCH	42
B.7.01	PROCEDURE	42
B.7.02	POINTS ALLOTTED	42
CHAPTER 8	- THE DRUM MAJOR CONTEST (QUICKSTEP).....	42
B.8.01	GENERAL	42
B.8.02	POINTS ALLOTTED	42
B.8.03	PROCEDURE	42
CHAPTER 9	- THE MARCH OFF DRILL CONTEST	43
B.9.01	GENERAL	43
B.9.02	POINTS ALLOTTED	43
B.9.03	PROCEDURE	43
B.9.04	TROPHIES	43
B.9.05	ALTERNATIVE	43
PART C	- MINIATURE BAND CONTESTS.....	45
CHAPTER 1	- GENERAL	45
C.1.01	APPLICATION OF GENERAL RULES	45
C.1.02	MINIATURE BAND	45
C.1.03	SUBSTITUTES	45
C.1.04	UNIFORM	45
C.1.05	DRAW	45
C.1.06	ATTENDANCE OF BANDS AND LATENESS.....	46
C.1.07	CONTACT BETWEEN JUDGES AND PLAYERS	46
C.1.08	JUDGING SHEETS.....	46
C.1.09	TIES.....	46
C.1.10	OFFICIALS	46
C.1.11	JUDGES.....	47

C.1.12	JUDGING.....	47
C.1.13	MOVEMENT OF BANDS.....	47
C.1.14	AGGREGATE CONTESTS.....	47
CHAPTER 2 -	THE CONTEST	48
C.2.01	MUSIC AND POINTS ALLOTTED.....	48
C.2.02	BAND FORMATION AND PROCEDURE	48
PART D -	SOLO CONTESTS.....	49
CHAPTER 1 -	SOLO PIPING & DRUMMING CONTESTS	49
D.1.01	GENERAL	49
D.1.02	REGISTRATION AND GRADING.....	49
D.1.03	ENTRIES AND DRAW.....	49
D.1.04	MUSIC.....	50
D.1.05	POINTS ALLOTTED.....	50
D.1.06	SPECIAL PROVISIONS.....	50
D.1.07	AGGREGATE CONTESTS.....	50
D.1.08	DRESS	51
D.1.09	JUDGING.....	51
D.1.10	MOVEMENT OF PLAYERS	51
D.1.11	CONTACT BETWEEN JUDGES AND PLAYERS	51
D.1.12	ENTRIES FROM REGISTERED PLAYERS ONLY.....	51
D.1.13	OFFICIALS	51
D.1.14	JUDGES.....	52
D.1.15	JUDGING SHEETS.....	52
[CHAPTER 2 -	STAFF FLOURISH CONTESTS rescinded 1995].....	52
CHAPTER 3 -	GROUPS OF PIPERS	52
D.3.01	CONTEST.....	52
D.3.02	COMPLIMENT.....	52
D.3.03	DRESS	53
D.3.04	GRADING.....	53
D.3.05	MUSIC.....	53
D.3.06	JUDGES.....	53
D.3.06	CONTEST OPERATION AND ADMINISTRATION	53
CHAPTER 4 -	DRUM MAJOR'S CONTEST (SOLO)	54
D.4.01	DRUM MAJOR'S CONTEST (SOLO).....	54
D.4.02	POINTS ALLOTTED.....	54
D.4.03	PROCEDURE	54
D.4.04	POINTS AWARDED	55
D.4.05	PENALTIES	55

D.4.06	AGGREGATE CONTESTS.....	55
PART E - PROMOTION OF CONTESTS.....		57
CHAPTER 1 - GENERAL		57
E.1.01	REGISTRATION OF CONTESTS	57
E.1.02	ACCEPTANCE OF ENTRIES	57
E.1.03	FACILITIES TO BE SUPPLIED.....	57
E.1.04	MASSED BANDS.....	57
E.1.05	PRIZE MONEY	57
CHAPTER 2 - CONTEST FORMAT AND GROUND LAYOUT		58
E.2.01	GROUND LAYOUT.....	58
E.2.02	DRAW	58
Confirmation of Association/Branch responsibilities – Rule A.1.12		59

NOTE:

The Australian Pipe Band Contest Regulation 2019 replaces earlier regulation of the same name incorporating amendments made since the previous issue and reflects the determinations of National Council following ballot of bands on proposals received. It takes effect on 1 July 2019.

The Regulation is the successor to the Australian Pipe Band Contest Rules of the former Australian Federation of Pipe Band Associations. The present format was authorised at a meeting Brisbane in June 1979, and the drafting of the previous patchwork of rules into a uniform style and layout was begun on the journey back from that Brisbane meeting more than twenty-five years ago. The Rules in this format were adopted at a meeting in Hobart in 1981. Previously the Federation Rules applied only to national championships, or as adopted by State Associations, but from 1981 they became applicable to all Australian pipe band contests.

Australian Pipe Band College - Rules & Administration Division

Principal:	Jamie Forsyth
Principal Emeritus:	Anthony Sell, B.A.(Hons), LL.B, Grad. Dip. Theol. Barrister & Solicitor of the Supreme Court of Victoria (Retired).
Vice-Principals	Ross Connolly (Victoria) Dorothy Keers (NSW) Hilton Bradford (WA) Jamie Robinson (Qld) Tony Bidgood (Tas)

PART A - GENERAL

CHAPTER 1 - RULES OF GENERAL APPLICATION

A.1.01 TITLE AND CITATION

- A.1.01.01 These Rules may be cited as "The Australian Pipe Band Contest Regulation 2019".
- A.1.01.02 An individual Rule may be cited by the letter of the Part within which it is found and its number, thus- this Rule is Rule A.1.01 and this clause of the Rule is A.1.01.02.

A.1.02 DEFINITIONS

In these Rules,

"the Association" means the Pipe Bands Australia Inc.;

"Branch" means a Branch of the Association;

"Committee" means the Committee of the Association;

"the College" means the Australian Pipe Band College.

"Contest Circle" means the circles marked on the ground in accordance with Rules B.3.03.02 and B.4.03.02;

"Contest Element" means any one of the Quickstep, March Strathspey & Reel / Selection of Marches, Medley, Display, The Dress Inspection, The Street March and March Off Drill Contest provided for in these Rules respectively;

"Contest Supervisor" means the official appointed by the Association to ensure that a Contest is conducted in accordance with these Rules;

"Council" means the Council of the Association.

"Promoter" means the person, body or group conducting a Contest;

"Registered" in respect of a Judge or Contest Supervisor includes appointment to a List of Judges or Contest Supervisors maintained by a Branch and "registered through a Branch" in such respect has a corresponding meaning

"Section" means the contest in a grade of Piping or of Drumming, or, where there is more than one contest in a grade, each such discrete contest;

Reference to a "List" of Judges or Contest Supervisors shall include a reference to a "Panel" and vice versa.

A.1.03 APPLICATION OF THESE RULES

- A.1.03.01 These Rules apply to all pipe band, miniature pipe band, piping, drumming, and drum major contests in Australia registered with the Association.
- A.1.03.02 The Association may from time to time prescribe such local and minor conditions and special conditions of entry to a contest as it may determine, promptly notifying all Branches.

A.1.04 PENALTIES

- A.1.04.01 Any breach of these Rules shall be cognisable by the Association, or if it arises on the day of a contest, by the Contest Supervisor, and such action shall be taken in relation to it as is deemed necessary provided however that although a band may infringe these Rules, that band shall not be prevented from completing the Contest Element.

A.1.04.02 A solo player who, or a band or miniature band which or of which any member breaches these Rules shall be subject to any penalty prescribed in the Rule so breached, and if there be none, may be reprimanded or disqualified from the whole or any part of a contest.

A.1.04.03 The registration of a contest, the promoter of which fails or refuses to comply with these Rules, may be suspended or cancelled.

A.1.05 PROTESTS

A.1.05.01 A protest (which must be in writing and accompanied by a fee of \$100.00 for a protest by a band, and \$25 for a protest by a solo player and lodged with the Contest Supervisor by the protesting solo player or the Band Representative of the protesting band within 30 minutes of the time of receipt of judging sheets noted in the Association's records, or the giving of the decision or doing of the act or thing complained of) shall be cognisable by the Contest Supervisor, who may either proceed therein as in a proper manner, consulting or hearing any person, or refer the same to the Association.

A.1.05.02 A party to a protest may appeal to the Branch with which a contest is registered against a decision by the Contest Supervisor by forwarding notice in writing thereof, specifying the grounds of the appeal, to reach the Secretary of that Branch within fourteen days of the contest.

A.1.05.03 The Branch with which a contest is registered shall have power to act after a contest in respect of a breach of these Rules referred to it by, or not brought to the notice of the Contest Supervisor at the contest.

A.1.05.04 If the protest is not upheld the protest fee shall be forfeited to the Branch, but if the protest is upheld then the initial fee shall be refunded.

A.1.05.05 A party aggrieved by the determination of an appeal to a Branch or by a decision of a Branch under this Rule may appeal from that determination or decision to the Appeals Committee, or a Branch may refer any matter arising for its consideration under this Rule to the Appeals Committee.

A.1.05.06 The Appeals Committee shall consist of the President and Secretary for the time being of the Association and Principal of Rules and Administration for the time being of the Australian Pipe Band College, and
(1) in the case of an appeal brought under this Rule, one representative nominated by the Branch against the determination or decision of which the appeal is brought or by which the matter is referred, and, if different, one representative nominated by the Branch through which the aggrieved party is affiliated or registered, and
(2) in the case of an appeal from a decision of the Adjudication Committee, one representative of each Branch by whom the appeal is brought or by a player or band registered through which an appeal is or the original complaint was brought, and of each Branch, if different, to whose relevant Branch list a person complained of is appointed.

A.1.05.07 The Appeals Committee may conduct a hearing in such manner as it finds convenient, the costs of which shall be borne in relation to an appeal brought under this Rule, by the aggrieved party or the Branch referring a matter, and in relation to an appeal from the Adjudication Committee, by the aggrieved party.

A.1.05.08 A decision of the Appeals Committee shall be binding on and given effect by the Branches and members of the Association.

A.1.06 OFFICIALS

- A.1.06.01 A Branch shall roster one or more persons from its Active List to act at a Contest, a Contest Supervisor so rostered shall be empowered to ensure the contest is conducted in accordance with these Rules. Rule A.1.09.10 applies to the rostering of a Contest Supervisor(s) at an Australian Pipe Band Championship.
- A.1.06.02 The Contest Supervisor may exercise, in addition to all powers and discretions expressly conferred by these Rules, during and for the purposes of a contest, all powers and discretions conferred on the Association by these Rules, and such powers and authority as may be necessary to carry out the duties imposed on the Contest Supervisor by this Rule. In respect of powers and discretions conferred on the Association by these Rules the Contest Supervisor shall not act contrary to the express directions of the Association.
- A.1.06.03 A Branch shall maintain an Active List of all persons appointed by it to be Contest Supervisors.
- A.1.06.04 An application for appointment to the List of Contest Supervisors shall contain the particulars of the applicant from time to time prescribed by the Committee, and, if the applicant is not already a member of the association it shall be accompanied by an application for membership in the prescribed form, and it shall be submitted together with a written endorsement of the application by two bands currently registered with the Association, and two personal references as to good character. A Branch shall either refer an application for appointment as a Contest Supervisor to the Rules & Administration Division of the appropriate Branch of the College for assessment or maintain a Committee howsoever styled of persons on the List of Contest Supervisors to make that assessment. The assessment shall consider the need to confine the membership of a List to persons regarded within the pipe band movement and the Association as being highly skilled and competent in the relevant area and of good character and reliable honesty in carrying out their functions if appointed, and shall take into account any involvement by way of trade or for profit in supplying goods to bands or individual musicians ["trade involvement"] and any information as to financial obligations to bands or involvement [whether direct or indirect] in financial losses suffered by bands ["involvement in loss"] or in established instances of dishonesty ["dishonesty"]. Where the assessing body is or becomes aware of any suggestion of trade involvement, involvement in loss or dishonesty by an applicant it shall report the circumstances to the Secretary seeking the advice of the Committee and the application shall not proceed without the express approval of the Committee which may grant or withhold it without being obliged to assign any reason therefor.
- A.1.06.05 A person shall not be eligible for appointment to the list of Contest Supervisors unless holding at least the Advanced Rules Certificate of the College or its recognised equivalent, provided that a person not holding such a Certificate may be appointed in a temporary capacity for a specific contest.
- A.1.06.06 A Branch shall also maintain a Reserve List of Contest Supervisors to which it may from time to time transfer any person from the Active list; a Contest Supervisor on the Reserve List shall hold the status of Contest Supervisor in all respects but shall not be eligible for rostering to act as Contest Supervisor at any Contest.
- A.1.06.07 Unless the Association otherwise determines, a Contest Supervisor who has not acted as such at a contest for a continuous period of two years shall be transferred to the Reserve List.

- A.1.06.08 A Contest Supervisor may be transferred from the Reserve List to the Active List of Contest Supervisors after assessment of an application therefor in accordance with Rule A.1.06.04.
- A.1.06.09 [Rescinded 2004]
- A.1.06.10 Each Branch shall forward a copy of its Active and Reserve Lists of Contest Supervisors to the Association and to each other Branch at least once in each year.
- A.1.06.11 The Association Panel of Contest Supervisors shall include an Active List only, appointed in the manner set out in Rule A.1.09.

A.1.07 JUDGES

- A.1.07.01 A Branch shall maintain an Active lists of all persons appointed by it to be Judges of Piping and Drumming, including Ensemble accreditation where applicable, and of Dress and Drill.
- A.1.07.02 An application for appointment to a List of Judges shall contain the particulars of the applicant from time to time prescribed by the Committee, and, if the applicant is not already a member of the association it shall be accompanied by an application for membership in the prescribed form, and it shall be submitted together with a written endorsement of the application by two bands currently registered with the Association, and two personal references as to good character. A Branch shall either refer an application for appointment as a Judge to the relevant division of the appropriate Branch of the College for assessment or maintain a Committee howsoever styled of persons on the relevant list of judges to make that assessment. The assessment shall consider the need to confine the membership of a List to persons regarded within the pipe band movement and the Association as being as being highly skilled and competent in the relevant area and of good character and reliable honesty in carrying out their functions if appointed, and shall take into account any involvement by way of trade or for profit in supplying goods to bands or individual musicians ["trade involvement"] and any information as to financial obligations to bands or involvement [whether direct or indirect] in financial losses suffered by bands ["involvement in loss"] or in established instances of dishonesty ["dishonesty"]. Where the assessing body is or becomes aware of any suggestion of trade involvement, involvement in loss or dishonesty by an applicant it shall report the circumstances to the Secretary seeking the advice of the Committee and the application shall not proceed without the express approval of the Committee which may grant or withhold it without being obliged to assign any reason therefor.
- A.1.07.03 A person shall not be eligible for appointment to be a Judge unless holding at least the relevant Advanced Certificate of the College or its equivalent recognised by the College and having satisfactorily completed the College's Adjudicator's course and being a financial member of the Association, provided that a person not holding such a Certificate may be appointed in a temporary capacity for a specific contest.
- A.1.07.04 A Branch shall also maintain a Reserve List of Judges of Piping, of Drumming and of Dress and Drill to which it may from time to time transfer any person from the relevant Active List of Judges to the relevant Reserve List: a Judge on the Reserve List shall hold the status of a Judge in all respects but shall not be eligible for rostering to adjudicate at any contest.
- A.1.07.05 Unless the Association otherwise determines, a Judge who has not adjudicated at a contest during a continuous period of two years shall be transferred to the relevant Reserve List.

- A.1.07.06 [Rescinded 2004].
- A.1.07.07 A Judge may be transferred from the Reserve List to the Active List of Judges after assessment of an application therefor in accordance with Rule A.1.07.02.
- A.1.07.08. Each Branch shall forward a copy of its Active and Reserve Lists of Judges to the Association and to each other Branch at least once in each year.
- A.1.07.09 The Association Panels of Judges shall include in each case an Active List only, appointed in the manner set out in Rule A.1.09.

A.1.08 BEHAVIOUR

- A.1.08.01 A person being a Contest Supervisor or Judge, or other official pursuant to these Rules at a pipe band contest, or officer or member of a band or a solo player registered or affiliated with the Association shall not behave in an unseemly or unbecoming manner whilst engaged in or attending any function or activity to which these Rules apply.
- A.1.08.02 The Contest Supervisor may deal with a breach of this Rule in accordance with Rules A.1.04 and A.1.05 or report it to the Association for its consideration and the Association may deal therewith as it may think fit, provided that the person reported is advised at least seven days prior to the meeting of the Association (or its appropriate governing body or other group) of that meeting, that the report will be considered at it, and that that person is entitled to attend and to address the meeting.

A.1.09 ADJUDICATION COMMITTEE

- A.1.09.01 The Adjudication Committee shall consist of the President of the Association and the Principals of the College for the time being.
- A.1.09.02 The Adjudication Committee shall review the composition of the Association Panels of Judges and of Contest Supervisors at least once in each two years, and may appoint a candidate to a list in accordance with this Rule, or suspend or remove an adjudicator or Contest Supervisor from a List on the grounds of lack of current experience required there for under this Rule.
- A.1.09.03 Appointment to an Association Panel shall be terminated by the written resignation therefrom of a member, and upon a member ceasing to be a member of a relevant Panel maintained by a Branch, and otherwise in accordance with these Rules.
- A.1.09.04 A person shall not be a candidate for appointment to an Association Panel unless that person is qualified for appointment as a judge under Rule A.1.07.03 or a Contest Supervisor under Rule A.1.06.05, has held appointment to that Active List maintained by a Branch for not less than three years, and has during that period effective appropriate experience as an adjudicator or Contest Supervisor, including regular rostering for Grade 1 or Grade 2 competitions, or other appropriate experience approved by the Adjudication Committee including taking a significant part in the tuition of a registered band allocated to Grade 1 or Grade 2 provided that a candidate who has not regularly been so rostered may carry out not less than three trials at such competitions under the supervision of the relevant Principal or the nominee of the relevant Principal, in such manner as is thought fit (having regard to economy and the convenience of those involved), the first such trial to be conducted after the candidate has held appointment to the Branch Active List for at least two years. The Adjudication Committee, while retaining its unfettered discretion in any particular case, may from time to time issue guidelines in relation to that appropriate experience for the assistance of all concerned. The Adjudication Committee shall not be required to assign any reason for its decision in relation to any candidate.

- A.1.09.05 The Adjudication Committee shall at each review of the Association Panels of Judges and Contest Supervisors consider as a candidate for appointment to those Panels each member of the Active List maintained by each Branch who is qualified under this Rule. The Adjudication Committee [by means of the appropriate Principal of the College] shall consult the relevant Vice-Principal of the College, prior to each such review, in relation to each candidate for or member of each Panel and take the advice so given into account in carrying out its review. The Adjudication Committee is to ensure that the persons appointed by it to each List are appropriate for the maintenance of the highest standards of probity and honesty in carrying out their duties.
- A.1.09.06 The Adjudication Committee shall meet in such manner as it finds convenient.
- A.1.09.07 A person appointed to an Association Panel pursuant to this Rule shall not thereby cease to be a member of the corresponding List or Panel maintained by a Branch.
- A.1.09.08 The Secretary of a Branch shall forward a copy of each List of judges and Contest Supervisors maintained by that Branch to the Secretary during the month of May in each year. The Secretary shall forthwith forward a copy of each list to each Principal of the College to enable the seeking of advice in accordance with this Rule.
- A.1.09.09 The Adjudication Committee when nominating a panel, from the Association List, of judges for rostering at an Australian Pipe Band Championships, required under Rule B.1.10.06, and approval of proposed judges from overseas, shall include the Vice Principals from the Branch in which the Australian Championships is to be held.
- A.1.09.10 The Principal Rules & Administration, the Vice Principal Rules & Administration in the Branch where an Australian Pipe Band Championships is to be held and the Association President shall determine the rostering of a Contest Supervisor(s) from the Association List of the Branch Concerned, and if need be from another Branch. In a Branch where there is no Vice Principal Rules & Administration the Branch President shall act in lieu.
- A.1.10 COMPLAINTS ABOUT ADJUDICATION**
- A.1.10.01 A player or band registered or affiliated with a Branch, a person appointed to be a judge or contest supervisor under these Rules or a Branch may lodge a complaint with the President of the Association in relation to any action, decision, conduct or the integrity of any member of an Association or Branch panel.
- A.1.10.02 Such a complaint shall be in writing, supported by affidavits or statutory declarations vouching it, and shall be lodged within 14 days of the doing of the act giving rise to the complaint.
- A.1.10.03 The President shall cause a copy of the complaint and supporting material to be forwarded promptly to all members of the Adjudication Committee and to each person against whom a complaint is brought.
- A.1.10.04 The Adjudication Committee shall meet, without delay, to consider the complaint, affording an opportunity for each person against whom complaint is brought to respond to the complaint by affidavit or statutory declaration or in person.
- A.1.10.05 The Adjudication Committee may dismiss a complaint, or find it sustained and counsel, admonish, suspend or remove from the Association or Branch Panel a person against whom that complaint has been brought.
- A.1.10.06 The Adjudication Committee shall promptly notify its decision in relation to a complaint to the complainant, to each person complained against, and to each Branch.
- A.1.10.07 A person or body lodging a complaint or a person against whom a complaint is brought who is aggrieved with the decision of the Adjudication Committee on that complaint

may appeal against that decision to the Appeals Committee in accordance with Rule A.1.05.

A.1.11 AMENDMENT OF THESE RULES

A.1.11 This Regulation may only be amended in the manner set out in Rule 24.1 of the Association's Rules and any amendment shall take effect from the time [not being less than two months after that amendment is made] specified by the Council or Committee at the time it is made, and if no time is so specified, after sixty days from the making of that amendment.

A.1.12 BRANCHES

A.1.12.01 The Association may delegate the conduct or administration of any matter under these Rules to a Branch.

A.1.12.02 A Branch shall deal with any matter committed to its conduct or administration by the Association in accordance with the directions of the Council and Committee of the Association.

A.1.12.03 Until otherwise determined by the Council or the Committee, a reference in these Rules to the Association shall be taken to be a reference to the appropriate Branch of the Association.

A.1.13 TRIAL RULES

A.1.13.01 The Council or the Committee of the Association may from time to time approve the use of a provision not contained within this Regulation ["Trial Rule"] in contests conducted within the area of responsibility of one or more Branches for a period not exceeding two years.

A.1.13.02 A Trial Rule shall take effect on such date as the Council or Committee nominates and may be used within the relevant Branch or Branches as an alternative to the provisions of this Regulation except at an Australian Pipe Band Championship or [unless expressly so authorised by Council or Committee] at a Branch Pipe Band Championships. When so used it shall have effect as if part of this Regulation.

A.1.13.03 The Association shall promptly inform all Branches of the approval of a Trial Rule.

A.1.13.04 A Branch within whose area of responsibility the use of any Trial Rule is authorised shall promptly inform all bands and contest promoters within that area of the approval of that Trial Rule and also of its expiry.

A.1.13.05 While a Trial Rule is approved for use within the area of responsibility of a Branch, that Branch may determine whether or not it is to be in effect at and with respect to any particular contest and shall so notify its bands and each relevant promoter accordingly.

Note: The Declaration authorising branches to exercise certain powers under this Regulation is set out at the end of this Regulation.

CHAPTER 2 - GRADING OF BANDS

A.2.01 GRADES

- A.2.01.01 A Branch shall upon a band first registering with it allocate it to a Grade, and shall from time to time (and on the direction of the Association's Grading Committee) review the grading of all bands registered with it. A Branch may at any time review the grading of a band either of its own motion or on the application of that band. A review of grading shall be carried out in accordance with these Rules.
- A.2.01.02 A band shall be graded Grade 1, Grade 2, Grade 3, or Grade 4a or Grade 4b. Contests may be conducted only in these grades and for Juvenile, Juvenile Novice A and Juvenile Novice B bands.
- A.2.01.03 Where a band has more than one registered contest band those bands may combine (wholly or partly) in a Display or Street March, but that band shall enter in the highest grade to which any such contest band is allocated.
- A.2.01.04 Except as otherwise expressly provided in these Rules, a player shall not compete with more than one band at any Contest.
- A.2.01.05 A band shall not compete in a grade lower than that to which it is allocated, but it may, subject to the Promoter's right to refuse multiple entries, and to the Association's right to direct that multiple entries be not accepted, compete in a higher grade than its own.
- A.2.01.06 For the purposes of these Rules, Grade 1 shall be higher than Grade 2, Grade 2 than Grade 3, Grade 3 than Grade 4a, Grade 4a than Grade 4b.

A.2.02 REVIEW OF GRADING

- A.2.02.01 The Association shall appoint a Grading Committee to recommend to the Committee of the Association the allocation of bands to grades, consisting of:
- (1) The President of the Association as Chairman;
 - (2) The Principal of Piping for the time being of the College;
 - (3) The Principal of Drumming for the time being of the College;
 - (4) The Principal of Ensemble for the time being of the College;
 - (5) the Secretary of the Association as Secretary.
- If the allocation to grading of a band of which a member of the Grading Committee is a registered player or a tutor is to be put to a vote, that member shall not vote on the matter nor enter into debate on it.
- A.2.02.02 The Association's Grading Committee shall from time to time and in accordance with this Rule publish guidelines for the grading of bands in Australia.
- A.2.02.03 A Branch shall appoint a Grading Committee to recommend to the Association's Grading Committee the allocation of bands to grades, consisting of
- (1) The Chairman of the Branch as Chairman;
 - (2) The Vice-Principal of Piping for the time being for the Branch, and two other piping judges elected from time to time by the Piping Advisory Panel for the Branch;
 - (3) The Vice-Principal of Drumming for the time being for the Branch, and one other drumming judge elected from time to time by the Drumming Advisory Panel for the Branch;
 - (4) A suitable person to act as Secretary.
- A Vice-Principal unable to attend a meeting of the Committee may appoint a Piping or Drumming Judge (as the case requires) as representative at that meeting. If the

allocation to grading of a band of which a member of the Grading Committee is a registered player or a tutor is to be put to a vote, that member shall not vote on the matter but shall leave the meeting place while the vote is put.

- A.2.02.04 The Chairman and Secretary of the Grading Committee and of a Branch Grading Committee shall not have a deliberative vote, but the Chairman shall have a casting vote in the event of an equality of votes.
- A.2.02.05 The Secretary of a Grading Committee shall maintain appropriate records of contest results for the assistance of the Committee.
- A.2.02.06[a] Within two months after each Australian Pipe Band Championships, the Association's Grading Committee shall publish its guidelines to each Branch and Branch Grading Committee.
- A.2.02.06[b] A Branch Grading Committee shall prepare and forward to the Secretary of the Association its recommendation for the allocation to grades of all bands registered through that Branch, to reach the Secretary by a date fixed by the Association Committee: this recommendation shall be based on all relevant information material available to that Committee, may include a recommendation that a band be not allocated to a grade where there is no recent evidence to support an allocation and shall be accompanied by a summary of all representations made to the Branch Grading Committee.
- A.2.02.06[c] Before a Branch Grading Committee adopts a recommendation under this Clause, the Vice-Principal of Piping and of Drumming being members of that Committee shall consult with the Principal of Piping and the Principal of Drumming respectively.
- A.2.02.07 The Secretary shall promptly upon receipt forward a copy of each Branch Grading Committee recommendation to each member of the Association's Grading Committee, and shall arrange a meeting of the Association's Grading Committee to formulate its recommendation for the allocation of bands to grades after all Branch Grading Committee recommendations are received, or the date by which they were required, whichever is the earlier. The Association's Grading Committee shall formulate its recommendation based on all relevant material available to it. The Secretary of the Association shall forward a recommendation of the Association's Grading Committee without delay to the Association Committee.
- A.2.02.08(a) A band which has not been allocated to a grade or a Grade 1, 2 3, 4a band which has not competed during a continuous period of two years shall not be entitled to lodge an entry for a contest until it has been allocated or re-allocated to a grade in accordance with Rule A.2.02.10. When a Branch Grading Committee so allocates or re allocates a band to a grade it shall forthwith inform the Secretary of the Association's Grading Committee.
- A.2.02.08(b) A Branch may resolve grading submissions from its bands on an annual basis within a prescribed period before their contest season commences, and that Grade 4a bands that have not competed for a continuous period of two or more years be allocated to Grade 4b, and Grade 4b bands remain in Grade 4b in lieu of being ungraded.
- A.2.02.09 A Judge officiating at a contest who considers in the light of that contest that a band is allocated wrongly shall so report to the Contest Supervisor, who shall inform the Secretary of the Branch through which the band is registered. The Secretary of the appropriate Grading Committee shall thereupon call a meeting of the Committee to consider the matter.

Commented [JF1]: Amended as suggested by Tim

- A.2.02.10 A band desiring its allocation to be reviewed shall apply, in writing, to the Branch through which it is registered, which shall so notify the Secretary of its Grading Committee who shall call a meeting of that Committee to consider the application at which the band shall be entitled to be represented as set out in this Rule.
- A.2.02.11 When arranging a meeting to consider an application for review from a band, or if the Branch Grading Committee concludes that a case exists to change the allocation of a band, the Secretary of that Committee shall so advise that band, which may if it so desires be represented by the Pipe-Major, Drum-Major, Drum-Sergeant and its tutors at a meeting of that Grading Committee to be called for that purpose. The Grading Committee shall consider any representations made by the band and determine its recommendation attaching to it a fair summary of any representations made to it by the band.
- A.2.02.12 After each review of allocation, or consideration of a report from a Judge or an application by a band pursuant to this rule, the Branch Grading Committee shall report to the Association's Grading Committee and if it has determined that there should be an alteration to the allocation of a band it shall include in each report a recommendation in that regard. The Association's Grading Committee shall consider each such recommendation and promptly submit its recommendation in relation to it to the Committee of the Association.
- A.2.02.13 The Committee of the Association shall deal with a recommendation from the Association's Grading Committee without amendment or debate on the merits of the matter.
- A.2.02.14 The Committee of the Association shall from time to time [and if possible, not less than once in each two years] arrange a meeting of the Principals and Vice-Principals of the College to consult on grading policy and like matters.

A.2.03 JUVENILE BANDS

- A.2.03.01 A player may compete as a member of a Juvenile band until the end of the period of registration with the Association during which that player attains 18 years of age.
- A.2.03.02 On first registering with a Juvenile band, a player shall submit proof of age to the satisfaction of the Association.
- A.2.03.03 Eligible players in an affiliated band (or in Contest Bands of an affiliated band) graded Grade 1, 2, 3, 4a or 4b may also compete with a band entered by that affiliated band in a Juvenile band contest.

CHAPTER 3 - REGISTRATION OF BANDS AND THEIR PLAYERS

A.3.01 REGISTRATION OF PLAYERS

- A.3.01.01 A person shall not be eligible to play in a contest with a band until 14 days after that band has registered that person as a player for contest in the manner from time to time prescribed by the Association (except as the Association otherwise determines) and, if registered as a player for contest by another band, that band has furnished a clearance confirming that the player is under no financial or like obligation to that band.
- A.3.01.02 [Rescinded 2011]
- A.3.01.03 A person ceases to be registered as a player for contest with a band on the lodging with the Association of a clearance from that band or of an application for registration as a player with another band.

A.3.02 CLEARANCES

- A.3.02.01 A person who has been refused or denied a clearance required for the purposes of this Chapter may apply to the Association for that clearance.
- A.3.02.02 The Association shall promptly enquire into the circumstances and grant the clearance unless it is satisfied that the player is not free of financial or like obligation to the band refusing the clearance and that the band has not had sufficient time, not exceeding six months from the time of application for clearance, to initiate appropriate action for the recovery of dues claimed.

A.3.03 MULTIPLE BANDS

- A.3.03.01 This rule applies where a band desires to register more than one separate band ("contest band") in contest, and the Association is satisfied that there is a genuine nexus between those contest bands.
- A.3.03.02 Each Contest Band must register bona fide players at least sufficient to form the minimum complement for the relevant grade set out in these Rules.
- A.3.03.03 The Contest Band graded into the highest grade (as defined in Rule A.2.01.06) shall be styled that band's No. 1 band, the Contest Band graded into the next lower grade (as so defined) shall be styled the No. 2 band and so on, unless otherwise authorised by the Association.
- A.3.03.04 (a) Each Contest Band shall be a discrete band for contest purposes, and the rules and practices relating to clearance and transfer of players shall apply as if the Contest Band were an affiliated band, subject to this Rule;
- (b) On an affiliated band registering more than one Contest Band it shall allocate its registered players to one or other Contest Band;
- (c) On a player first registering with that affiliated band, that player shall be registered with a specific Contest Band;
- (d) A Contest Band other than a No. 1 Band may nominate no more than four interchange players who may play in the affiliated band's next higher graded Contest Band, provided that an interchange player who plays in the higher grade more than three times in any period of two years shall thereupon be transferred to the higher graded Contest Band. The Band Representative shall notify the Contest Supervisor, in writing, prior to each Contest Band with whom interchange players are registered competing (except in a Display or Street March in which both such Contest Bands are

wholly or partly combined) of the Contest Band, if any, with which each such interchange player is competing at that contest.

(e) A player may be registered specifically as a piper, snare drummer, tenor drummer, bass drummer, or drum-major with one and in a different such capacity with another Contest Band and may so compete.

(f) In the Display, if a band enters more than one band made up of players of more than one contest band the Drum Major may compete with more than one such band.

- A.3.03.05 A Contest Band shall be entitled to fees, travelling allowances and appearance moneys at contests and Association engagements provided that it complies with the complement provisions of these Rules at contests and at an engagement as if it were a contest.

A.3.04 ANNUAL REGISTRATION OF BANDS AND THEIR PLAYERS

- A.3.04.01 Each band shall annually (at a date prescribed by the Association) register its players for contest, and furnish such other particulars as the Association from time to time prescribes, and pay the annual fee for registration fixed by the Association and any approved levy imposed by the Branch with which it seeks registration.

- A.3.04.02 The Association shall maintain records of the bands currently registered, and of the persons currently registered as players for contest with each band.

A.3.05 CONTEST ENTRIES FROM REGISTERED BANDS ONLY

- A.3.05.01 Entries for Pipe Band contests and miniature band contests shall be accepted only from bands which are at the time of entering currently registered with the Association or, in respect of bands not based in Australia, recognised by the Association as duly registered by virtue of registration with an affiliated overseas pipe band association (however titled). Only a band so registered or recognised as duly registered on the day of a contest shall be permitted to compete.

- A.3.05.02 A band shall not take part in a contest not registered either with the Association under these Rules or with an affiliated overseas pipe band association.

A.3.06 TUTORS

- A.3.06.01 A band allocated to Grade 4a, 4b or competing in a Juvenile, Novice Juvenile A or Novice Juvenile B band contest may register one piping and one drumming tutor as a player for a contest.
- A.3.06.02 A player registered as a tutor is also eligible to compete with another band, so long as that band is not competing in the same grade at a contest as the band in which he or she is registered as a tutor.
- A.3.06.03 A tutor shall not be registered as such by more than one band at any time and a drumming tutor shall not perform as a leading snare drummer.
- A.3.06.04 The provisions of clause A.3.01 shall apply to tutors registered as such under this clause.
- A.3.06.05 A person shall not be eligible to be registered as a tutor under this rule unless that person holds at least the relevant Intermediate Certificate of the Australian Pipe Band College or its equivalent recognised by the College.
- A.3.06.06 A registered tutor may wear the uniform of the band of registration as a player whilst playing as a tutor under this rule if that band is also playing at that contest, in which case the Contest Supervisor shall be so informed by the band with which the tutor is playing in that capacity, and the tutor shall not be judged for dress while so playing.

A.3.07 DUAL REGISTRATION

- A.3.07.01 A player registered with a Grade 4b, 4a or 3 band (“the band of registration”) and with the written approval of that band and of the relevant Branch of the Association may compete as a player (“dual registered player”) with a higher graded band (“the senior band”) at the same contest as defined in this Rule.
- The Branch shall forthwith inform the Association Registrar of that approval.
- A.3.07.02 A dual registered player may compete twice at the same contest as follows:
- (1) with the band of registration in its allocated grade if entered;
- and either
- (2) (a) in a Juvenile band contest as a member of the band of registration in accordance with Rule A.2.03;
 - or
 - (2) (b) with the senior band in either its allocated or a higher Grade.
 - (3) if a dual registered player’s band of registration is not competing at a contest that player may compete with the senior band as if a registered player of that band.
- A.3.07.03 The number of dual registered players eligible to compete with a senior band shall not exceed four.
- A.3.07.04 Rule A.3.01.01 applies in the registration of a dual registered player with the band of registration and the senior band but no clearance shall be required.
- A.3.07.05 A dual registered player shall compete in the registered uniform of the band of registration and the senior band as applicable.
- A.3.07.06 No special consideration shall be given to a dual registered player when preparing a draw under Rule B.1.05.
- A.3.07.07 When a senior band intends to play a dual registered player in a contest it shall furnish with its entry for that contest the name of each such player and the player’s band of registration.
- A.3.07.08 The band representatives of the band of registration and the senior band shall on the day of the contest inform the Contest Supervisor in writing of the name of each dual registered player competing with the senior band at that contest.
- A.3.07.09 This Rule only applies to contests in accordance with Part B of the Australian Pipe Band Contest Regulation.
- A.3.07.10 Nothing in this rule shall preclude up to four dual registered players, approved in accordance with A.3.07.01, from competing with the nominated “senior band” at a contest where their “band of registration” is not competing as indicated in A.3.07.02 (3) providing the requirements of Rules A.3.07.07 and A.3.07.08 are complied with.

PART B - BAND CONTESTS

CHAPTER 1 - APPLICABLE TO ALL BAND CONTESTS

B.1.01 CONTESTS

- B.1.01.01 The Rules set out in Part A of these Rules apply.
- B.1.01.02 Each contest shall consist of as many of the Contest Elements as the Association may approve provided that an Australian Pipe Band Championship shall consist of:
- (1) an aggregate contest comprising a March Strathspey & Reel / Selection of Marches and a Medley; and
 - (2) a Dress Inspection not included in the aggregate result; and may include:
 - (3) one or more marching elements as prescribed in the Contest Regulations (except for a Juvenile band contest) not included in any aggregate result. Where the quickstep, limited area quickstep or display is offered, these shall be optional.
- B.1.01.03 The several Contest Elements of any contest may be conducted separately (with separate draws for order of play pursuant to Rule B.1.05 if the Association so directs) in which case each band shall be allowed if possible at least one hour and in no case less than thirty minutes from the conclusion of its performance in one Contest Element before it is called upon to play in another.
- B.1.01.04 Contest Elements may be conducted consecutively, in which case a band competing in both shall be allowed at least ten minutes from the conclusion of its performance in the first before being called upon to play in the second, and during that time it shall be permitted to tune its instruments and alter its complement in an area designated by the Contest Supervisor.

B.1.02 COMPLEMENT

- B.1.02.01 A band may include a Drum Major and as many pipers and drummers as it thinks fit, provided that a band competing in Grade 1 shall include at least 8 pipers, 3 snare drummers, and 1 bass drummer, and in any other grade and in a Juvenile band contest at least 6 pipers, 2 snare drummers and 1 bass drummer, and a band competing in the Quickstep or Display shall also include a Drum Major and a band competing in the Street March may include no more than 4 Drum Majors.
- B.1.02.02 The complement of a band shall not be altered during a Contest Element, and for this purpose the Dress Inspection, if conducted after a Contest Element, shall be deemed to be part of that Contest Element.
- B.1.02.03 The complement of a band may be altered from one Contest Element to another, and for this purpose players may be added to or withdrawn from a band for any particular Contest Element: when two Contest Elements are conducted together, the Band Representative shall obtain the approval of the Contest Supervisor for the arrangements for an alteration of complement between those Contest Elements, and the Contest Supervisor may authorise standard arrangements for alteration of complement at a contest.
- B.1.02.04 A player competing with a band shall be either the Drum Major, or a piper or a drummer and shall act in the accepted and traditional manner throughout the Contest Element. If any player does not comply with this paragraph the band shall be penalised 5% of the points allotted for the Contest Element, but Rule B.1.11.02 applies in relation to an Australian Pipe Band Championship.

B.1.02.05 If a player suffers an injury or illness so as to be unable to compete with a band strictly in accordance with these Rules in any respect, the Contest Supervisor may upon production of satisfactory evidence of such incapacity permit that player to compete with the band and shall notify the Dress and Drill Judges of his decision, and those Judges shall have regard to such injury or illness when judging that band.

B.1.03 SUBSTITUTES

B.1.03.01 If the Contest Supervisor is satisfied that the Drum Major or bass drummer of a band has become unable to compete with the band through accident or other misfortune, the Contest Supervisor shall select by ballot, after taking into account all relevant circumstances, a Drum Major or bass drummer (as the case requires) from those of the band's grade at that contest to play as substitute.

B.1.03.02 The Contest Supervisor shall notify the Drumming, Dress and Drill Judges of any substitution pursuant to this Rule.

B.1.03.03 A player shall not be judged while acting as substitute.

B.1.04 UNIFORM

B.1.04.01 A band shall compete in its accepted Pipe Band uniform approved by the Association.

B.1.04.02 The uniform of all members of a band shall be the same except in the following minor details: feather bonnets, swords, dirks, skean dhu, sashes, pennants, lanyards, epaulettes in respect of Pipe Major, Drum Major, Pipe Sergeant and Drum Sergeant; badges of rank; leopard skins and feather bonnets in basic section; standard differences in tartan and accepted and traditional style of dress between pipers and drummers, provided however that if the Contest Supervisor shall permit a player to compete with a band pursuant to Rule 1.02.05 of this Part, the Contest Supervisor may also direct the Dress Judge to disregard any infringement of this Rule resulting from the player being unable, by reason of injury or illness to comply in all respects with this Rule, and provided further that the Association may permit an individual difference for reasons of religious belief or ethnic tradition.

B.1.04.03 There shall be no deliberate alterations to uniform or equipment (or addition thereto or removal therefrom) during:

a Contest Element; or

successive Contest Elements conducted together, provided that where one such Contest Element is the Medley the basic section drums and drumsticks (or any of them) may be changed between the Contest Elements, the Band Representative or other person or persons so authorised by the Contest Supervisor attending for the purpose and the exchange proceeding without delay.

B.1.04.04 Only minor adjustment may be made to uniform and equipment between the conclusion of a Contest Element and the commencement of a Dress Inspection conducted in accordance with Rule B.6.03.

B.1.01.05 In the event of inclement weather the Contest Supervisor may cancel the Dress Inspection at a contest generally or for a grade.

B.1.05 DRAW

B.1.05.01 Each draw for order of play shall be conducted either by the Promoter in the presence of a representative of or by the Association, as the Association may direct.

- B.1.05.02 The Promoter (or, if it so directs, the Association) shall notify all competing bands of the order of play and the expected timetable at least 21 days prior to the contest in the case of Australian and State or Branch Pipe Band Championships and 14 days prior to the contest in all other cases.
- B.1.05.03 A band entering the contest late shall play before the first or after the last band so drawn, or, with the approval of the Association, in place of a band so drawn which has withdrawn from the contest.
- B.1.05.04 The Contest Supervisor may for good cause suddenly and unforeseeably arising, or on the application of a band, vary the order of play so that the band shall play first or last in its grade or in an interval in the timetable.

B.1.06 ATTENDANCE AND LATENESS

- B.1.06.01 An official shall call each band to the arena twice, the second call to be at least five minutes after the first. Calls shall be made on the arena.
- B.1.06.02 A band not at the starting point on the arena and ready in all respects to proceed within five minutes after the second call shall forfeit five points, and a band not at that point and ready in all respects to proceed within ten minutes of the second call shall be disqualified unless the Contest Supervisor is satisfied that the lateness was caused by matters outside the band's control and should be excused, but Rule B.1.11.02 applies in relation to an Australian Pipe Band Championship.
- B.1.06.03 A band entering for a contest shall appoint a Band Representative, endorsing the name on its entry form. Any change in this appointment shall be notified by the band to the Contest Supervisor as soon as possible on the day of the contest.
- B.1.06.04 The Band Representative is responsible for the prompt attendance of the band and for liaison between the officials and the band.
- B.1.06.05 A band shall not be required to take part in any Massed Band or other function until it has completed its competition for the day.

B.1.07 CONTACT BETWEEN JUDGES AND PLAYERS

- B.1.07.01 Except as provided in Rule B.1.15 and in this Rule, a Judge shall not approach within three paces of a band during its performance of a Contest Element, nor enter within the outer marked circle during a band's performance of the March Strathspey and Reel / Selection of Marches or the Medley.
- B.1.07.02 Except as provided in Rule B.1.15 and in this Rule, an officiating Judge shall not have any contact or conversation with any competitor, member or official of a competing band during a Contest Element.
- B.1.07.03 A competitor, member or official of a competing band shall not contact or communicate with a Judge officiating during a Contest Element.
- B.1.07.04 Except by permission of the Contest Supervisor a competitor, member or official of a competing band (other than the Band Representative in the course of performing duties as such) shall not enter or remain on the arena except for the purpose of competing with that band.
- B.1.07.05 Nothing in this Rule shall prevent a Dress Judge, except at an Australian, State or Branch Pipe Band Championship, from inviting the Drum Major of a band to accompany the judge on the Dress Inspection and the Drum Major may do so.

B.1.08 JUDGING SHEETS

- B.1.08.01 The Association shall provide judging sheets, in duplicate, in respect of each Contest Element for each competing band.
- B.1.08.02 After judging, a judge shall pass the judging sheets to the official as directed by the Association: the official shall check them and enter the total on the Master Sheet.
- B.1.08.03 When all judging sheets relating to a band in respect of a Contest Element have been so checked and entered, the original copies shall be available to the Band's Representative, the duplicate copies being retained by the Association, an official noting thereon or in other convenient way the time of delivery to the Band Representative, provided that the time of delivery shall be deemed to be no later than 30 minutes after the sheets are announced to be so available.
- B.1.08.04 The results of a contest shall be provisional until the expiration of the time within which a protest may be lodged and until the determination of any protest.
- B.1.08.05 A Judge who notices a breach of these Rules shall draw it to the attention of the Contest Supervisor and endorse on the judging sheet that a band has in a particular case breached these Rules.

B.1.09 TIES

- B.1.09.01 An apparently tied result in a Contest Element or in the aggregate result of a contest, shall be resolved thus:-
- (1) if the Contest Element is judged for ensemble, by reference first to the ensemble total and second to the March, Strathspey & Reel / Selection of Marches total, or an Australian Pipe Band Championships, placing; and
- (2) if the Contest Element or contest is not judged for ensemble, by reference first to the piping total and second to the drumming total.
- If this reference does not separate the bands the results shall be a tie.
- B.1.09.02 An apparently tied result in an aggregate contest for the best Pipe or Drum Corps a tied result shall be split by reference to the points, or placing in accordance with Rule B.1.11.02, allocated for the March, Strathspey & Reel / Selection of Marches as applicable.
- If this reference does not split the bands the result shall be a tie.

B.1.10 OFFICIALS

- B.1.10.01 Rule A.1.06 applies.
- B.1.10.02 The Promoter shall roster, subject to the approval of the Association, appropriate Officials competent to carry out the duties necessary to give effect to these Rules.
- B.1.10.03 Subject to the general supervision of the Contest Supervisor, the officials shall be responsible for the orderly movement of bands to, on and from the tuning area and the arena, and for checking the duration of the Dress Inspection and of each performance in the Medley. Under the supervision of the Contest Supervisor, an official shall check judging sheets, enter the points on the Master Sheet, and prepare the results of the contest.
- B.1.10.04 A Branch shall roster judges, as prescribed by these Rules, as necessary for a contest [other than an Australian Pipe Band Championship] registered through it, from the lists of judges maintained by it or another branch or the list maintained by the Association: a Branch may so roster a judge on the Association list, its own list, or a judge on the list of

another branch who is ordinarily resident in the State in which the contest is to be held, or a judge not normally resident in Australia whose rostering has first been approved by the Adjudication Committee and it shall to the fullest extent possible enable all judges on its list or resident in its State to share fairly in the available rosters and to maintain currency of experience so as to remain on an Active List.

B.1.10.05 If the Contest Supervisor approves, the duties of the judges in relation to the movement of bands may be carried out by an official.

B.1.10.06 A Branch shall roster judges, as prescribed by these Rules, for an Australian Pipe Band Championship contest registered through it from the list of judges maintained by the Association or being not normally resident in Australia and expressly approved by the Adjudication Committee. At least six months before each such contest, a Branch shall advise the Adjudication Committee of the number of judges on each list whom it desires to roster for the contest, and of the number and particulars of persons not normally resident in Australia whom it desires so to roster: the Adjudication Committee shall promptly nominate a panel setting out twice as many judges from the Association list as the Branch intends to roster judges [other than from outside Australia] and shall indicate whether or not each proposed judge from overseas is approved. The Branch shall roster only judges from that panel or so approved for the contest.

B.1.11 JUDGES

B.1.11.01 Subject to Rule B.1.11.02, the number of Judges to be rostered shall be:-

- (1) for the Quickstep, at least one piping, one drumming, one drill and one dress judge;
- (2) for the Medley or the March Strathspey & Reel/Selection of Marches, at least one piping and one drumming judge;
- (3) for a Dress Inspection, at least one dress judge.
- (4) for the Street March, at least one piping, one drumming and one drill judge;
- (5) for the Display, at least one piping, one drumming and two drill judges;
- (6) for the March Off Drill Contest, at least one drill judge.

B.1.11.02 At an Australian, State or Branch Pipe Band Championship, a band shall be judged in each contest element comprising the championships pursuant to Rule B.1.01.02 by two piping judges, one ensemble judge and one drumming judge. At an Australian Pipe Band Championship each judge shall complete the judging sheets in the usual way for the assistance of bands competing, but shall not allocate any points thereon: each judge shall pass to the scorers a list setting out the bands in each grade and contest element in order serially from first placing to last without any equal placing. The scorer shall take a first ranking as 1 point, a second ranking as 2 points and so on serially. The band with the least points shall be the winner, and so on serially. Where a band would otherwise incur penalty:

- (1) under Rules B.1.02.04, or B.1.06.02 one point shall be added to its total for each such penalty, and
- (2) under Rule B.4.01.02, one point shall be added to its total for each 15 seconds by which the performance falls short of the minimum or exceeds the maximum time prescribed.

B.1.11.03 [rescinded 1995]

B.1.11.04 The Association may direct that judges officiate at more than one Contest Element at a contest, or that separate judges be appointed for any Contest Element.

B.1.11.05 If at any contest more than one judge be rostered to judge a band in any aspect, and if any other aspect of the band's performance is judged by fewer judges, then in each aspect the total of the points allotted to the band shall be divided by the number of judges judging that aspect after all judges' points have been entered on the Master Sheet and the result of that division shall be the points gained by the band for that aspect for the purposes of scoring.

B.1.12 DRUM MAJOR

B.1.12.01 A Drum Major may give orders by voice, hand signal or mace signal and only in the Display by whistle, or a combination of these and not otherwise.

B.1.13 BAND FORMATION

B.1.13.01 Band formation shall consist of ranks and files in accordance with this Rule, and where not specified as the band sees fit.

B.1.13.02 The front rank and the outside files (except, if necessary, in the bass drummer's rank) shall be complete provided that if a band performs in the Medley or the March Strathspey & Reel / Selection of Marches with fewer snare drummers than files of pipers the snare drummers may cover the inner files whilst in band formation. The front rank shall consist of no fewer than four pipers, except that in the Quickstep it shall consist of four pipers. There shall be at least two ranks of pipers. A rank of drummers may consist of five drummers, and in the Medley and the March Strathspey Reel / Selection of Marches, of any number of drummers. A Drum Major shall form a rank in front of the front rank.

B.1.13.03 The intervals between ranks and between files of pipers shall be two paces, except that the Drum Major shall be three paces in front of the front rank and centred in front of the centre file of pipers or between the two inner files of pipers, and the bass drummer may be in the centre of his rank which shall be three paces from the rear rank of pipers. Where feasible each drummer shall cover a file (and for this purpose the Drum Major is a file). For the purposes of this Rule, "pace" means a pace of .75m.

B.1.13.04 A rank shall not consist of both pipers and drummers, or of both basic section and snare drummers.

B.1.13.05 If a band competing in the Street March has:

(1) one Drum Major, the formation set out in B.1.13.03 shall apply;

(2) two Drum Majors they shall form one rank three paces in front of the front rank of pipers in accordance with B.1.13.02 and B.1.13.03;

(3) three or four Drum Majors then one shall comply with B.1.13.03 and the others shall form the front rank three paces behind that Drum Major and three paces in front of the front rank of pipers.

B.1.14 JUDGING

B.1.14.01 Judging of Piping and Drumming, and if applicable Ensemble, shall commence on the Drum Major, or if there be no Drum Major, the Pipe Major, being directed to proceed and shall cease on the last note played.

B.1.14.02 A band shall not be penalised for the setting of the music played.

B.1.14.03 When a band is judged for Drill, judging of drill shall commence on the Drum Major, or if there be no Drum Major, the Pipe Major, being directed to proceed and shall cease when the band standing easy on completing the Contest Element.

B.1.15 MOVEMENT OF BANDS

- B.1.15.01 A band shall move to the entrance of the arena and to the prescribed starting point for the Contest Element with instruments at the ready and to the Dress Inspection point, when the Dress Inspection follows a Contest Element, as directed by the officials and with instruments at the order.
- B.1.15.02 Subject to Rule B.1.10.05, a band shall move off after a Contest Element during which the Dress Inspection is conducted when notified by the Dress Judge, who shall not so notify the band until satisfied that the judging of piping and drumming in that Contest Element is concluded and in any other case, the band shall move off when notified by the drill judge if one is officiating, and if not by the piping judge. The band shall move as directed by the officials.
- B.1.15.03 The Contest Supervisor may define the boundaries of the arena and of the tuning area, and may also define the boundaries of a silent area adjoining the arena. Such boundaries shall be notified by notice at the scoring point. A player shall not play (except while actually competing) or tune an instrument on the arena or in a silent area except in exceptional circumstances and with the prior permission of the Contest Supervisor or in accordance with Rule B.1.01.04. Playing or tuning in tuning areas shall be under the direction of the officials.
- B.1.15.04 Unless otherwise directed by an official, a band leaving the arena shall give way to a band entering the arena.
- B.1.15.05 A band may, with the prior permission of the Contest Supervisor, play while leaving the arena.

B.1.16 AUSTRALIAN PIPE BAND CHAMPIONSHIPS

- B.1.16.01 Rule B.1.11.02 applies.
- B.1.16.02 [Rescinded 1997]
- B.1.16.03(a) The Australian Pipe Band Championships shall be held in each State as the Association shall determine, as nearly as possible in rotation;
- B.1.16.03(b) Expressions of interest shall be invited from the Branches by December of the year three years prior to the year in which the particular Championships contest is proposed to be held {"that year"};
- B.1.16.03(c) If no such expression of interest is received by April of the year two years before that year, then expressions of interest shall be invited from interested persons;
- B.1.16.03(d) If no such expression of interest is received by the end of June of the year two years before that year then tenders shall be invited for the conduct of the contest. The invitation shall be in the form and contain the information from time to time directed by the Committee, including the relevant provisions of this Regulation, fees and costs payable to the Association and the costs and responsibilities of the promoter;
- B.1.16.03(e) During the month of December of the year two years before that year the Committee shall select a tender and allocate the conduct of the Championship contest to the successful tenderer; and
- B.1.16.03(f) On execution of the relevant agreement between the Association and the selected tenderer the Championship contest shall be deemed to have been registered pursuant to Rule E.1.01 of this Regulation, and copies of the relevant tender and agreement shall forthwith be furnished to that Branch.
- B.1.16.04 [Rescinded 2004]

- B.1.16.05 The trophies for the Australian Pipe Band Championship shall remain the property of the Association. Certificates shall be issued to winners of trophies. The winner of a trophy who is registered through a Branch may hold that trophy for a period of three months from the contest date, thereupon delivering the trophy in good order to its Branch which shall forward it to the Branch in whose jurisdiction the next Championship is to be held at least three months before the next Championship. That winner shall bear the costs of any necessary repair to the trophy and of so forwarding it.
- B.1.16.06 When a Quickstep is conducted at the contest at which the Australian Championships are conducted, it shall be styled "The Australian Quickstep Championships".
- B.1.16.07 When a Display is conducted at the contest at which the Australian Championships are conducted, it shall be styled "The Australian Pipe Band Display Championships."
- B.1.16.08 A band shall be eligible to lodge an entry to compete at an Australian Pipe Band Championship if and only if
- (1) it has been registered with the Association or affiliated association for at least six months; and
 - (2) throughout that period of six months there have been players comprising the minimum complement prescribed in Rule B.1.02 for its grade registered as players for contest with the band.

CHAPTER 2 - THE QUICKSTEP

B.2.01 MUSIC

B.2.01.01 The music shall be one or more marches in compound time, commenced with 2 three-pace drum rolls, but Grade 1 bands shall play at least two such marches in rotation.

B.2.02 POINTS ALLOTTED

B.2.02.01 The maximum points allotted shall be 370, thus:

- (1) Piping 100
- (2) Drumming 50 [expressed on the sheet as 100 and divided by two to give 50]
- (3) Drill 120
- (4) Dress 100 [being the points allocated for the Dress Inspection conducted in accordance with Rule B.1.01.02.]

B.2.03 JUDGING

B.2.03.01 Judging of Drill shall commence when the drill judge directs the Drum Major to proceed, and cease on the band standing easy at the end of the Quickstep course.

B.2.04 COURSE AND MOVEMENTS

B.2.04.01 A competing band shall complete the course (in the appended diagram) in the manner set out in this Rule, moving parallel to the imaginary line connecting A-B-C-D at all times prior to the second right wheel prescribed in this Rule.

A course shall be marked with flags, on posts 50mm by 50mm and not less than 1.35m high of a conspicuous colour, the flags at A and D being white, at B, C1 and C2 blue, at E yellow and at F red.

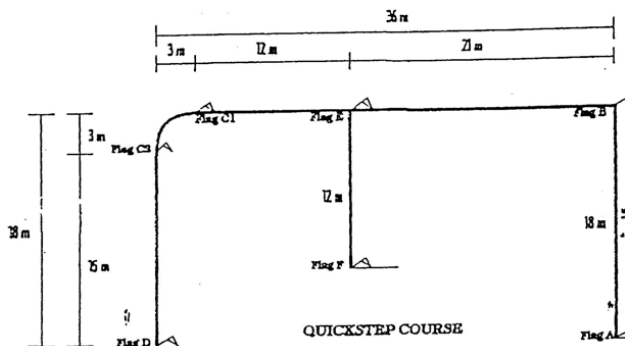

B.2.04.02 The drill judge, when satisfied that all judges are ready, shall direct the Drum Major to proceed.

B.2.04.03 The band shall march, playing, in band formation, from A to B, wheel left (box wheel) and march to C, wheel left (gate wheel) and march to D, there perform a front to rear flank to flank countermarch, march to C, wheel right (gate wheel) and march to E, wheel right (box wheel) and march to F, there perform a countermarch other than a front to rear flank to flank countermarch, and on reforming at F march to E and halt.

B.2.04.04 At E, the band shall so halt that the front rank is in line with and 1.35m. to the right of E. The Drum Major shall signal "Cease Playing" so that the band ceases playing at the end of a double forte part; the Drum Major shall turn about to face the band (whether

before or after signalling "Cease playing"), and, after the band ceases playing, order the band to stand at ease and stand easy.

Front to Rear, Flank to Flank Countermarch

B.2.04.05 The Front to Rear, Flank to Flank Countermarch shall be executed thus:

The Drum-Major shall proceed at least the band's length past D and, on giving the signal, turn about and move through the centre of the band, and may step one pace to the right to regain the centre position of the band. The band will proceed, each rank right about wheeling on the line on which the Drum Major turned about, then returning towards B, correcting its alignment and covering in relation to the Drum Major as each rank is clear of the rear rank; the rear rank shall after wheeling about conform to resume band formation.

The Bass Drummer shall move into the left inner file to enable the Drum Major to pass. When the whole band has wheeled about, the Drum Major, who shall be two paces past B towards C, shall signal to mark time and turn left. Bass and Tenor Drummers shall then continue to mark time, the remainder of the band turning left.

On a further signal by the Drum Major the pipers and snare drummers shall change flanks, each file right about wheeling and moving to resume their place in band formation, while the Drum Major, Bass and Tenor Drummers move forward one pace and continue to mark time. The Drum Major, when the leading man of each file passes the Drum Major's alignment, shall signal, turn to the front, then signal "Forward" stepping off on the left foot.

The Drum Major shall not turn to face the band while it counter marches but will look to the front throughout.

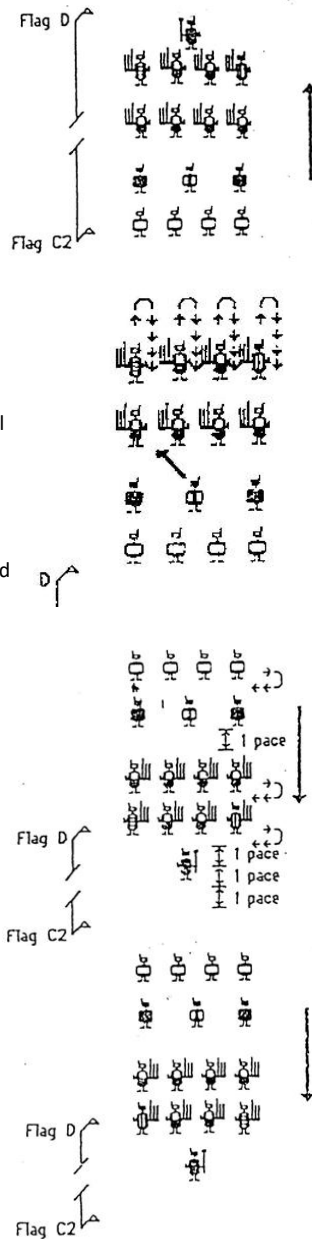

Box Wheels

B.2.04.06 Box wheels shall be executed thus:

On the signal, the inner flank guide shall step short and looking outwards gradually come round following an arc of 1.35m radius from the relevant flag. The outer flank guide shall look inward maintaining a pace of not more than .75m with the remainder of the rank holding the correct intervals and alignment throughout the wheel. As soon as the front rank begins to wheel, the remainder of the band shall maintain its forward movement at the same time gaining ground towards the outer flank by a combination of wheeling and inclining. As soon as the front rank is facing the required direction the Drum Major shall signal "Forward" and the band commence moving in the new direction. The front rank shall not mark time. The Drum Major will maintain position in the front of the band during the wheel by gaining ground towards the inner flank.

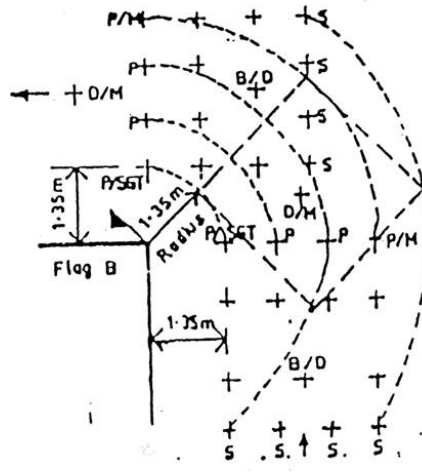

Gate Wheel

B.2.04.07 Gate wheels shall be executed thus:

On the signal the Drum Major, and then each rank, in succession, shall change direction through 90 degrees by pivoting on the flags, each player maintaining the distance from the flag while so pivoting. The outer files shall step out and inner files step short to maintain dressing. The band shall continue to advance throughout the execution of the wheel, and all ranks before and after so pivoting shall comply with Rule B.2.04.01. The band shall be in band formation at the commencement and conclusion of the gate wheel.

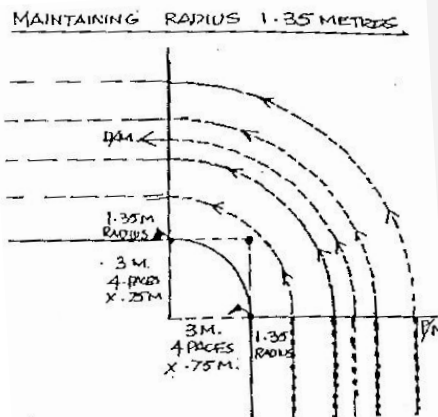

B.2.04.08 A band may take one check pace at the start or end of a movement, and in counter marches may mark time not more than four paces between movements.

B.2.05 NO JUVENILE QUICKSTEP

B.2.05.01 No Quickstep contest shall be conducted for Juvenile band contests.

CHAPTER 2A – THE LIMITED AREA QUICKSTEP

B.2A.01 MUSIC

B.2A.01 The music shall be one or more marches in compound time, commenced with 2 three-pace drum rolls.

B.2A.02 POINTS ALLOTTED

B.2A.02 The maximum points allotted shall be 300, thus:

(1) Piping	100
(2) Drumming	50 (expressed on the sheet as 100 and divided by 2 to give 50)
(3) Drill	120
(4) Dress	30

B.2A.03 JUDGING

B.2A.03 Judging of drill shall commence when the drill judge directs the Drum Major to proceed and cease on the band standing easy at the end of the Limited Area Quickstep course.

B.2A.04 COURSE AND MOVEMENTS

B.2A.04.01 A competing band shall complete the course (in the appended diagram) in the manner set out in this Rule, moving along an imaginary line centrally parallel to both imaginary lines A-B at all times prior to the right wheel prescribed in this Rule.

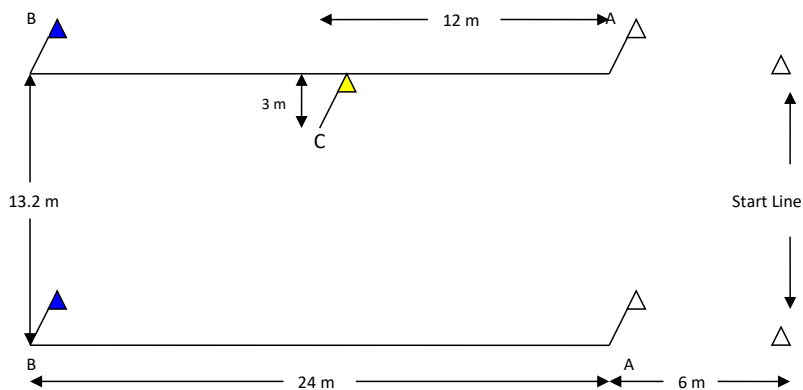

A course shall be marked with flags to the same specifications as prescribed in Rule B.2.04.01.

B.2A.04.02 The drill judge, when satisfied that all judges are ready, shall direct the Drum Major to proceed.

B.2A.04.03 The band shall march, playing, in band formation from the start line to the line B-B, there perform a counter-march other than a front-to-rear, flank-to-flank counter-march so as to reform on the line B-B, march to the line A-A, there perform a front-to-rear, flank-to-flank counter-march so as to reform on the line A-A, march to C and wheel right (box wheel) so as to halt and cease playing on C immediately upon completion of the box wheel.

- B.2A.04.04 At C, the band shall so halt that the front rank is in line with and 1.35 m. to the left of C. The band is to halt and cease playing at the end of the part of music at the conclusion of the box wheel, with or without a signal from the Drum Major, irrespective of whether the part of music is piano or double forte. The Drum Major shall turn about to face the band and order the band to stand at ease and stand easy.
- B.2A.04.05 The Front-to-Rear, Flank-to-Flank Counter-march shall be executed in accordance with Rule B.2.04.05.
- B.2A.04.06 The Box Wheel shall be executed in accordance with Rule B.2.04.06.
- B.2A.04.07 A band may take one check pace at the end or start of a movement and, in counter-marches, may mark time as a whole band not more than four paces between movements.

CHAPTER 3 - THE MARCH STRATHSPEY & REEL/SELECTION OF MARCHES

B.3.01 MUSIC

B.3.01.01 The music for Grades 1 and 2 shall be one 2/4 March, Strathspey and Reel each of not less than 4 parts.

B.3.01.02 The music for Grade 3 shall be one 2/4 March of 4 parts and one Strathspey and Reel each of 4 or more parts played once through.

B.3.01.03

- (1) The music for Grade 4a shall be 4 parts of 2/4 March (may be 2x2 parts), either 2 or 4 parts of Strathspey (may be 2x2 parts) and 2 or 4 parts of Reel (may be 2x2 parts).
- (2) The music for Grade 4b shall be 4 x 2-part march music. Music from the approved prescribed tune list.

B.3.01.04

- (1) The music for Juvenile shall be one 2/4 March of 4 parts and one Strathspey and Reel each of 4 or more parts played once through.
- (2) The music for Novice Juvenile A shall be Four parts 2/4 march (maybe 2x2), four parts strathspey (maybe 2x2), four parts reel (maybe 2x2).
- (3) The music for Novice Juvenile B shall be 4 x 2-part march music. Music from the approved prescribed tune list.

B.3.01.05 The music shall commence with 2 three-pace rolls.

B.3.01.06 For Grades 1, 2, 3 and 4a this Contest Element shall be styled "March Strathspey & Reel", and for Grades 4b, Juvenile, and Novice Juvenile A and B "Selection of Marches".

B.3.01.07 A band entering Grade 1 or Grade 2 shall submit with its entry two sets of tunes for the March Strathspey & Reel. The set to be played shall be determined by ballot in the presence of the Contest Supervisor (or a person nominated by the Contest Supervisor) at the start point for the element when the band, at the starting point on the arena, is ready in all respects to proceed and forthwith advised to the Pipe-Major and Drum-Major (if any).

B.3.01.08 Rescinded (2019).

Commented [JF2]: I suspect this is quite obvious now, given they're listed above. Could be rescinded?

Commented [JF3]: Agree here with Tim

B.3.02 POINTS ALLOTTED

B.3.02.01 Except at an Australian Pipe Band Championship, as to which see Rule B.1.11.02, each adjudicator shall allocate a score with a maximum of 100 points. The aggregate of these points shall be calculated in compliance with Schedule A as follows.

Schedule A			
Number of Adjudicators (and % of total score)			
Option	Piping	Drumming	Ensemble
1	2 (50% of total)	1 (25% of total)	1 (25% of total)
2	1*(50% of total)	1 (25% of total)	1 (25% of total)
3	2 (67 % of total)	1 (33% of total)	0
4	1*(67 % of total)	1 (33% of total)	0

"*" indicates that in these cases weighting of scores shall be adjusted to preserve the 2:1 ratio between piping and drumming points.

B.3.03 PROCEDURE

- B.3.03.01 The band shall assemble in band formation with the front rank on the line AA as shown in the diagram appended. The piping judge when satisfied that all judges are ready shall direct the Drum Major, or if there be no Drum Major, the Pipe Major, to proceed. The band shall come to attention, and march, playing, adopt its own choice of formation on or within the circles and halt, completing the music.
- B.3.03.02 There shall be concentric circles of 10 and 14 metres in diameter marked on the ground with a line drawn through the centre parallel to the line between flags AA as shown in the appended diagram.
- B.3.03.03 The music shall be played through without stopping in the order set out in Rule B.3.01.

B.3.04 WHEN ON STAGE OR DAIS

- B.3.04. Notwithstanding anything to the contrary in these Rules, when a March Strathspey & Reel / Selection of Marches contest is conducted on a stage or dais:-
 - A band may, if permitted by the Contest Supervisor, play while entering or leaving the stage or dais, but not be judged while so playing.
 - A band shall form a horseshoe formation on the stage or dais which may be in the general manner show in the diagram appended or an open / concert formation of its own choice.

The diagram referred to in Rules B.3.03 and B.4.05:

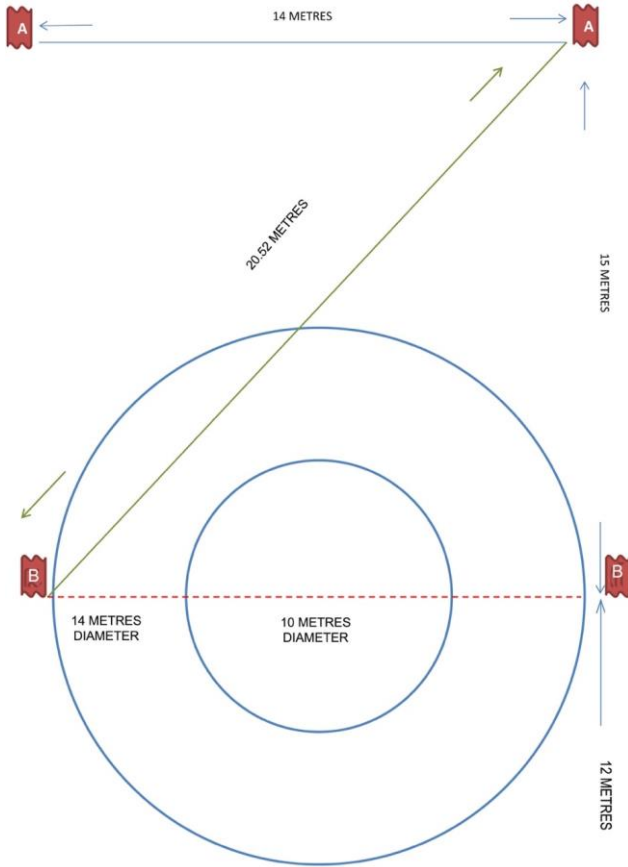

Recommended distance of 4 metres from flags to spectator viewing area.

CHAPTER 4 - THE MEDLEY

B.4.01 MUSIC

B.4.01.01: B.4.01.01 The music shall consist of a Medley of the band's own choice, not in aggregate to be:

- (1) for Grade 1, less than 5 or more than 7 minutes;
- (2) for Grade 2, less than 4 or more than 6 minutes;
- (3) for Grade 3 and Juvenile, less than 3 or more than 5 minutes;
- (4) for Grades 4A, less than 3 or more than 5 minutes;
- (5) for Grades 4b, Juvenile Novice A and Juvenile Novice B, less than 3 or more than 5 minutes. Inclusion of a Medley element for these grades will be at the discretion of the Promoter and Branch.

The performance shall be timed between the first and last piping or drumming notes played.

A band entering Grade 1 shall submit with its entry two sets of tunes for the Medley. The set to be played shall be determined by ballot in the presence of the Contest Supervisor (or a person nominated by the Contest Supervisor) at the start point for the element when the band, at entering the starting point on the arena, is ready in all respects to proceed and forthwith advised to the Pipe Major and Drum Major (if any).

B.4.01.02 A band shall be penalised 10 points for each 15 seconds or part thereof by which the performance falls short of the minimum time or exceeds the maximum time; these points shall be deducted from the total points awarded to that band in this Contest Element, but Rule B.1.11.02 applies in relation to an Australian Pipe Band Championship.

B.4.01.03 (Rescinded 2019)

B.4.02 POINTS ALLOTTED

B.4.02.01 Except at an Australian Pipe Band Championship, as to which see Rule B.1.11.02, each adjudicator shall allocate a score with a maximum of 100 points. The aggregate of these points shall be calculated in compliance with Schedule A as follows.

Schedule A			
	Number of Adjudicators (and % of total score)		
Option	Piping	Drumming	Ensemble
1	2 (50% of total)	1 (25% of total)	1 (25% of total)
2	1*(50% of total)	1 (25% of total)	1 (25% of total)
3	2 (67 % of total)	1 (33% of total)	0
4	1*(67 % of total)	1 (33% of total)	0

“*” indicates that in these cases weighting of scores shall be adjusted to preserve the 2:1 ratio between piping and drumming points.

B.4.03 PROCEDURE

B.4.03.01 The band shall assemble in band formation with the front rank on the line AA as show in the appended diagram. The piping judge when satisfied that all judges are ready shall direct the Drum Major, or if there be no Drum Major, the Pipe Major to proceed. The

band shall come to attention, and march, playing, adopt its own choice of formation on or within the circles and halt, completing the music.

- B.4.03.02 There shall be concentric circles of 10 and 14 metres in diameter marked on the ground with a line drawn through the centre parallel to the line between flags AA as show in the appended diagram.

B.4.04 PROCEDURE OPEN / CONCERT FORMATION

- B.4.04.01 The band shall assemble in band formation with the front rank on the line AA as shown in the diagram appended. The piping judge, or if applicable the Contest Supervisor, when satisfied all judges are ready shall direct the Drum Major, or if there be no Drum Major the Pipe Major to proceed. The band shall come to attention, and march, playing, adopt an open / concert formation, of its own choice, on or within the circles facing the audience and halt, completing the music.
- B.4.04.02 There shall be concentric circles of 10 and 14 metres diameter marked on the ground, with two flags on the circumference of the larger circle as shown in the appended diagram.
- B.4.04.03 A band adopting a formation where the Pipe Major occupies a position in front of the band, facing away from the audience, must ensure the distance between the Pipe Major and the nearest player(s) to the left and the right is not less than 4 paces (approximately 3 metres).
- A band adopting a formation similar to the diagrams referred to in Rule B.4.05 must ensure that the minimum distances between the players in the examples are adhered to.
- B.4.04.04 If a band adopts a circle formation and / or breaches Rule B.4.04.03 the band shall be penalised by the deduction of 10 points or by the addition of 1 point if placings apply under Rule B.1.11.02.
- B.4.04.05 The judges may for all or part of the performance adjudicate seated at a table adopting a consistent approach for all bands in a particular grade or a Juvenile band contest

B.4.05 WHEN ON STAGE OR DAIS

- B.4.05. Notwithstanding anything to the contrary in these Rules, when a Medley contest is conducted on a stage or dais:-
- A band may, if permitted by the Contest Supervisor, play while entering or leaving the stage or dais, but not be judged while so playing.
- A band shall form a horseshoe formation on the stage or dais which may be in the general manner show in the diagram appended or an open / concert formation of its own choice.

The diagram referred to in Rules B.3.04 and B.4.05:

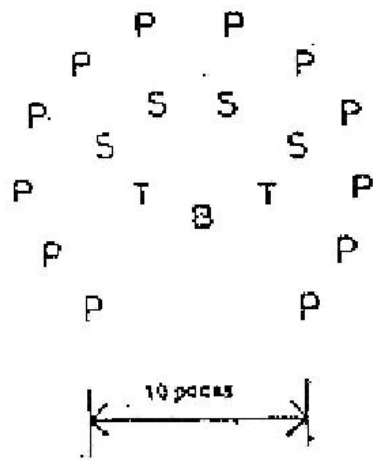
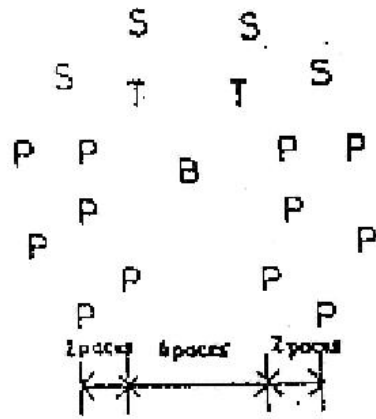

CHAPTER 5 - THE DISPLAY

B.5.01 THE DISPLAY

B.5.01 The Display Element shall be conducted for bands of all Grades in open competition, or restricted by Grade, at the discretion of the Promoter with the approval of the Association.

B.5.02 THE DISPLAY - FORMAT

- B.5.02.01 The Display shall be predominantly a series of continuous marching evolutions under the control of the Drum Major. These evolutions are to be performed whilst a band is playing music of its own choice.
- B.5.02.02 The Display shall be not less than four minutes nor more than eight minutes in duration.
- B.5.02.03 The Display shall be conducted within an area 60 metres by 40 metres. The corners of the contest area shall be marked by flags of conspicuous colours.
- B.5.02.04 Flags marking the contest area shall be on posts not less than 1.35m high and 50mm square.
- B.5.02.05 A band proceeding out of the marked area shall lose 10 points on each occasion, to be deducted from the drill points.

B.5.03 POINTS ALLOTTED

B.5.03 The maximum points allotted shall be 350, thus:

- | | | |
|--------------|-----|---|
| (1) Piping | 100 | Technical proficiency 40; Public appeal 60 |
| (2) Drumming | 50 | [Expressed as 100, in the proportions 40:60 on the sheet and divided by two to give 50, Technical proficiency 20Public appeal 30] |
| (3) Drill | 200 | [100 for each judge] Technical proficiency 40; Public appeal 60 |

B.5.04 PROCEDURE

- B.5.04.01 A band may play while entering or leaving the arena (if permitted by the Contest Supervisor) but shall not then be judged.
- B.5.04.02 The Drum-Major shall be directed to proceed by the Contest Supervisor (who shall also indicate to the judges that such a direction has been given).
- B.5.04.03 A band shall commence (in band formation) and finish its Display at positions of its own choice within the contest area.
- B.5.04.04 The judges shall officiate from vantage points off the arena.

CHAPTER 6 - THE DRESS INSPECTION

B.6.01 WHEN TO BE CONDUCTED

- B.6.01.01 The Dress Inspection shall be conducted either during the March Strathspey & Reel / Selection of Marches or Medley, or after a Contest Element as the Association directs.
- B.6.01.02 When the Dress Inspection is conducted during a Contest Element, Rule B.6.02 shall apply and Rule B.6.03 shall not apply.
- B.6.01.03 When the Dress Inspection is conducted after a Contest Element, Rule B.6.03 shall apply, and Rule B.6.02 shall not apply.

B.6.02 DRESS INSPECTION DURING CONTEST ELEMENT

- B.6.02.01 When the Dress Inspection is conducted during a Contest Element, judging shall commence when the judging of piping commences, and cease five minutes thereafter: if necessary, the band shall stand fast until that time has elapsed.

B.6.03 DRESS INSPECTION AFTER CONTEST ELEMENT

- B.6.03.01 When the Dress Inspection is conducted after a Contest Element, then:
 - (1) On being notified by the prescribed judge at the cessation of judging that Contest Element, the band shall march, in band formation, to the Inspection Point;
 - (2) Judging shall be carried out at that point, with the band in band formation, at the position of attention;
 - (3) Judging shall commence on the band reaching the Inspection Point, or, if the Association so directs, five minutes after the band reaches the Inspection Point, or on the Drum Major, or if there be no Drum Major, the Pipe Major, sooner notifying the official that the band is ready: judging shall cease five minutes thereafter, the official notifying the judge that the allotted time has expired;
 - (4) While at the Inspection Point the band shall remain in band formation.

B.6.04 POINTS ALLOTTED

- B.6.04.01 The maximum points allotted shall be 100.

CHAPTER 7 - THE STREET MARCH

B.7.01 PROCEDURE

- B.7.01.01 The Association may determine the course for the Street March. A Street March shall be judged for such distance as the Association determines.
- B.7.01.02 A band shall commence, perform and finish the Street March in band formation while playing its own choice of music and marching in quick time.
- B.7.01.03 Notwithstanding the provisions of Rule B.1.14, judging shall commence when the Drum Major (or, if there be no Drum Major, the front rank) passes the point designated by the Association, and cease when the Drum Major or front rank (as the case requires) passes the point designated as the conclusion of the distance determined pursuant to Rule B.7.01.01.
- B.7.01.04 The Association may direct that one or more wheel or countermarch [described in this regulation] be executed at one or more locations on the course.
- B.7.01.05 A band may compete with up to four Drum Majors as specified under Rule B.1.13.05.

B.7.02 POINTS ALLOTTED

B.7.02 The maximum points allotted shall be 300, thus:

- (1) Piping 100
- (2) Drumming 100
- (3) Dress & Drill 100

CHAPTER 8 - THE DRUM MAJOR CONTEST (QUICKSTEP)

B.8.01 GENERAL

- B.8.01.01 A contest for Drum Majors may, with the consent of the Association, be held in conjunction with a Quickstep contest.
- B.8.01.02 All Drum Majors in each grade shall be deemed to have entered the contest in that grade, but a Drum Major shall not be judged when playing as a substitute pursuant to these Rules.

B.8.02 POINTS ALLOTTED

- B.8.02.01 The maximum points allotted shall be 50.

B.8.03 PROCEDURE

- B.8.03.01 Judging shall commence when the drill judge for the Quickstep contest directs the Drum Major to proceed, and cease on the band standing easy at the end of the Quickstep course.

CHAPTER 9 – THE MARCH OFF DRILL CONTEST

B.9.01 GENERAL

B.9.01.01 A band competing in the Medley or the March, Strathspey & Reel in any Grade except Juvenile shall on completing either of those contest elements carry out the movements laid down in this Chapter as directed by the Association.

B.9.01.02 Notwithstanding Rules B.3.03 and B.4.03 additional flags shall be placed at C as shown in the appended diagram together dependent on whether a left or right wheel is to be executed.

B.9.02 POINTS ALLOTTED

B.9.02.01 The points allotted shall be: Drill 100 points

B.9.03 PROCEDURE

B.9.03.01 On being notified to proceed, the Drum Major, or if there be no Drum Major, the Pipe Major, shall direct the band to come to attention. The band shall then begin play and regain band formation and proceed towards the fence and perform a counter march of its own choice. The band shall then proceed to flag A there performing a gate wheel and proceed to flag C and shall cease playing at the end of the part as it approaches Flag C, but shall continue, marching towards the nominated exit from the arena.

Bands in Grades 1 to 3 inclusive shall play music in compound march time. Bands in Grade 4 shall play music in march time.

B.9.04 TROPHIES

B.9.04.01 Nothing in this Chapter shall prevent the awarding of a trophy to the band achieving highest drill points in a Quickstep element under the title "Best Drilled Band" in that Quickstep.

B.9.05 ALTERNATIVE

B.9.05.01 Notwithstanding this Chapter, the Association may authorise the conduct of a movement in like circumstances in accordance with Chapter 7 – The Street March.

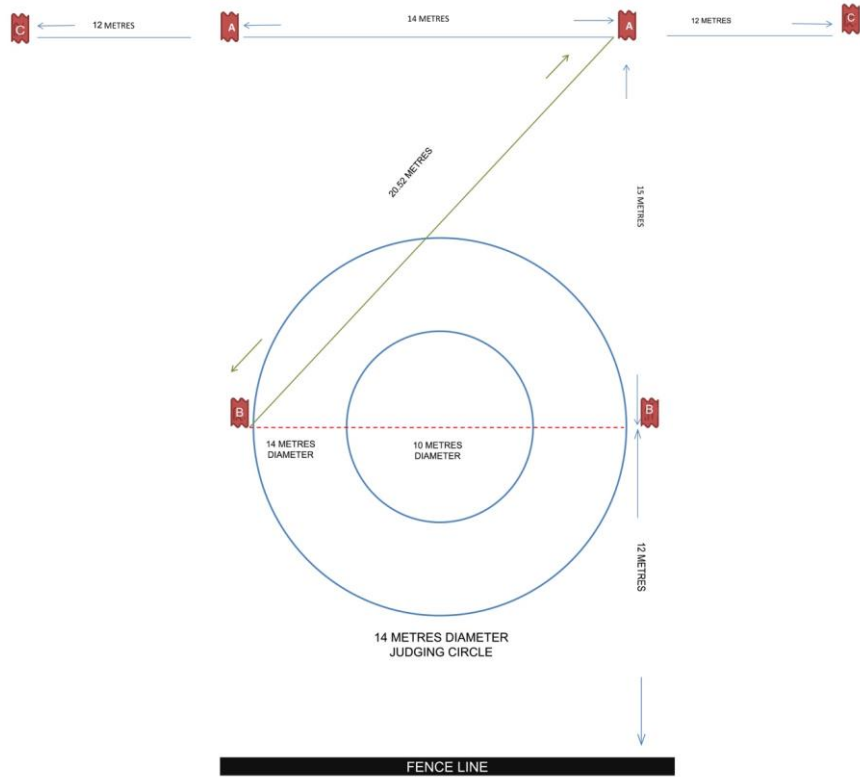

PART C - MINIATURE BAND CONTESTS

CHAPTER 1 - GENERAL

C.1.01 APPLICATION OF GENERAL RULES

C.1.01.01 The Rules set out in Part A of these Rules apply.

C.1.02 MINIATURE BAND

C.1.02.01 A miniature band is a group of the members registered for contest with a band comprising 4 pipers, 1 bass drummer and 2 snare drummers, and, if desired, 1 tenor or alto drummer, and shall be allocated to the grade to which that band is allocated.

C.1.02.02 The Pipe Major, bass drummer and leading snare drummer of a band may play as such in each miniature band comprised of members of that band and otherwise a player shall not play in the same capacity with more than one miniature band comprised of members of the same band.

C.1.02.03 The complement of a miniature band shall not be altered during a contest.

C.1.02.04 If a player registered with a band suffers an injury or illness so as to be unable to compete with the band strictly in accordance with these Rules in any respect, the Contest Supervisor may upon production of satisfactory evidence of such incapacity permit that player to compete with the band and notify the judges accordingly.

C.1.03 SUBSTITUTES

C.1.03.01 If the Contest Supervisor is satisfied that the bass drummer of a miniature band has become unable to compete with the band through accident or other misfortune, the Contest Supervisor shall select by ballot, after taking into account all relevant circumstances, a bass drummer from those of the band's grade at that contest to play as substitute.

C.1.03.02 The Contest Supervisor shall notify the drumming judge of any substitution pursuant to this Rule.

C.1.03.03 A player shall not be judged while acting as substitute.

C.1.04 UNIFORM

C.1.04.01 A miniature band shall compete in the accepted Pipe Band uniform of the band with which its members are registered for contest, approved by the Association pursuant to Rule B.1.04.

C.1.04.02 There shall be no deliberate alterations to uniform or equipment (or addition thereto or removal therefrom) during a contest.

C.1.05 DRAW

C.1.05.01 The Contest Supervisor shall conduct the draw for order of play in respect of a contest, and cause competing bands to be notified thereof as convenient.

C.1.05.02 The Contest Supervisor may vary the draw if satisfied that unforeseen circumstances have arisen, either from observation or on the application of a band, and may amend the draw to include a band entering late at the end of the draw or in an interval in the timetable.

C.1.06 ATTENDANCE OF BANDS AND LATENESS

- C.1.06.01 An official shall call each miniature band to the prescribed contest point twice, the second call to be at least five minutes after the first. Calls shall be made in the tuning area.
- C.1.06.02 A miniature band not at the contest point within three minutes after the second call shall be disqualified unless the Contest Supervisor is satisfied that the lateness was beyond the band's control and should be excused.
- C.1.06.03 A band entering a miniature band for a contest shall appoint a Band Representative, endorsing the name on its entry form. Any change in this appointment shall be notified by the band to the Contest Supervisor as soon as possible on the day of a contest.
- C.1.06.04 The Band Representative is responsible for the prompt attendance of the miniature band and for liaison between the officials and the band.

C.1.07 CONTACT BETWEEN JUDGES AND PLAYERS

- C.1.07.01 A judge shall not approach within three paces of a miniature band during its contest performance.
- C.1.07.02 Except as provided in Rule C.2.02, an officiating judge shall not have any contact or conversation during a contest with any competitor, member or official of a band which has entered a competing miniature band.
- C.1.07.03 A competitor, member or official of a band which has entered a competing miniature band shall not contact or communicate with a judge officiating during a contest.
- C.1.07.04 A competitor, member or official of a band which has entered a miniature band shall not move to or remain at or near the contest point so as to impede the contest or to interfere with the fairness of the contest.

C.1.08 JUDGING SHEETS

- C.1.08.01 The Association shall provide judging sheets in respect of each contest for each competing miniature band.
- C.1.08.02 After judging each band, a judge shall pass the judging sheet to an official who shall check it and enter the total on the Master Sheet.
- C.1.08.03 When all judging sheets relating to any band in respect of a contest have been checked and entered, they shall be made available to the Band's Representative.
- C.1.08.04 The results of a contest shall be provisional until the expiration of the time within which a protest may be lodged and the determination of any protest.
- C.1.08.05 A judge who notices any breach of these Rules shall draw it to the attention of the Contest Supervisor and endorse on the judging sheet that a band in a particular case has breached these Rules.

C.1.09 TIES

- C.1.09.01 At a contest an apparently tied result shall be resolved by reference to the piping points. If this does not separate the bands the result shall be a tie.

C.1.10 OFFICIALS

- C.1.10.01 Rule A.1.06 applies.
- C.1.10.02 The Promoter shall appoint, subject to the approval of the Association, the following:

- (1) Judges, as prescribed by these Rules, from the Association or Branch Panels of Judges;
- (2) Appropriate officials competent to carry out the duties necessary to give effect to these Rules.

C.1.10.03 Subject to the general supervision of the Contest Supervisor, the officials shall be responsible for the orderly movement of miniature bands to and from the tuning area and contest point. Under the supervision of the Contest Supervisor, the officials shall check judging sheets, enter the points on the Master Sheet and prepare the results of the contest.

C.1.10.04 [rescinded 1995]

C.1.10.05 If the Contest Supervisor approves, the duties of the judges in relation to the movement of bands may be carried out by an official.

C.1.11 JUDGES

C.1.11.01 At least one piping and one drumming judge shall be rostered at a miniature band contest.

C.1.11.02 If at any contest more than one judge be appointed to judge a band in any aspect, and if any other aspect of the band's performance is judged by fewer judges, then in each aspect the total of the points allotted to the band shall be divided by the number of judges judging that aspect after all judges' points have been entered on the Master Sheet and the result of that division shall be the points gained by the band for the purposes of scoring.

C.1.12 JUDGING

C.1.12.01 Judging of piping and drumming shall commence on the Pipe Major of the miniature band being directed by the piping judge to proceed, and shall cease on the last note played.

C.1.12.02 A band shall not be penalised for the setting of the music played.

C.1.13 MOVEMENT OF BANDS

C.1.13.01 A miniature band shall move to the contest point with instruments at the ready, as directed by the officials.

C.1.13.02 Subject to Rule C.1.10.05, a miniature band shall move off after a contest performance when directed by the piping judge, and shall move as directed by the officials.

C.1.13.03 The Contest Supervisor may define the boundaries of the arena and of the tuning area, and may also define the boundaries of a silent area adjoining the arena. Such boundaries shall be notified by notice at the scoring point. A player shall not play (except when actually competing) or tune an instrument on the arena or in a silent area except in exceptional circumstances and with the prior permission of the Contest Supervisor. Playing or tuning in tuning areas shall be under the direction of the officials.

C.1.14 AGGREGATE CONTESTS

C.1.14.1 In any seasonal aggregate contest, points shall be awarded thus: -

- (1) For 1st place 5 points
- (2) For 2nd place 3 points
- (3) For 3rd place 1 point

provided that if there be a tie between two miniature bands for 1st and 2nd, each shall be awarded 4 points, and between two for 2nd and 3rd, each shall be awarded 2 points;

between two for 3rd, each shall be awarded 0.5 points; between three or more for any place, the points for that place and any lesser place shall be divided equally between them and no lesser place shall be awarded.

CHAPTER 2 - THE CONTEST

C.2.01 MUSIC AND POINTS ALLOTTED

- C.2.01.01 The music for a miniature band contest may be determined by the Association, and in the absence of such a determination Rule B.4.01.01 shall apply.
- C.2.01.02 The points allotted shall be 150, thus:
- (1) Piping 100 points
 - (2) Drumming 50 points [expressed on the sheet as 100 and divided by two to give 50]
- C.2.01.03 The music shall be played through the number of times specified, and if there is no specification, once through only.
- C.2.01.04 A miniature band not complying with the specified music shall be disqualified.
- C.2.01.05 If the provisions of Rule B.4.01.01 apply to a miniature band contest [whether by determination of the Association or by default pursuant to clause C.2.01.01] a miniature band shall be penalised a points penalty of 10 points for each 5 seconds or part thereof by which its performance falls short of the minimum or exceeds the prescribed maximum time.
- C.2.01.06 If the Association so directs, at a contest each judge shall complete judging sheets in the usual way for the assistance of bands competing, but shall not allocate any points thereon: each judge shall pass to the scorers a list setting out the bands in each grade in order serially from first placing to last, without any equal placings. The scorer shall take a first ranking as 1 point, a second ranking as 2 points and so on serially. The band with least points shall be the winner, and so on serially. Where a band incurs a points penalty under this part one point shall be added to its total for each such penalty.

C.2.02 BAND FORMATION AND PROCEDURE

- C.2.02.01 The miniature band shall assemble in a formation of its own choice. The piping judge when satisfied the judges are ready shall direct the Pipe Major to proceed. The miniature band shall come to attention, commence playing and continue until completing the music. The miniature band shall move off when notified by the piping judge, contest supervisor or an official.
- C.2.02.02 (Rescinded 2017)
- C.2.02.03 Notwithstanding anything in these Rules, when a miniature band contest is conducted on a stage or dais, a miniature band shall form a horseshoe formation on the stage or dais.

The diagram referred to in Rule C.2.02

PART D - SOLO CONTESTS

CHAPTER 1 - SOLO PIPING & DRUMMING CONTESTS

D.1.01 GENERAL

- D.1.01.01 The Rules set out in Chapter 1 of Part A of these Rules apply.
- D.1.01.02 In this Chapter, "player" means a solo piper or solo drummer.

D.1.02 REGISTRATION AND GRADING

- D.1.02.01 A player shall register with a Branch of the Association in such manner as the Association from time to time directs.
- D.1.02.02 A registered player shall be graded by the Association on first registering. A player shall be graded A, B, C, D, Novice or Beginner. For the purposes of these Rules, A shall be higher than B, B than C and C than D. A player may be graded differently as a piper and a drummer, as a snare and a basic drummer, or for piobaireachd.
- D.1.02.03 The Association shall cause the grading of players to be reviewed annually in such manner as it may from time to time determine, on the advice of the Piping or the Drumming Advisory Panel as the case requires.
- D.1.02.04 A Judge officiating at a contest who considers in the light of that contest that a player is wrongly graded shall so report to the Contest Supervisor who shall inform the Association so that the matter may be considered.
- D.1.02.05 A player may apply to the Association for variation of grading and the Association shall then consider the application.
- D.1.02.05 The Association shall maintain records of the players currently registered and their grading.

D.1.03 ENTRIES AND DRAW

- D.1.03.01 The Association may give such directions in accordance with these Rules as to the arrangements for taking of entries for a solo contest as it may from time to time think fit, either generally or in respect of a particular contest or section.
- D.1.03.02 Upon closing of entries for a section, a draw for order of play shall be conducted by the Contest Supervisor or a person nominated by the Contest Supervisor. The draw shall be published in such manner as the Contest Supervisor determines.
- D.1.03.03 If a section (other than an Open or a Piobaireachd section) attracts more than 15 entries it shall be divided into Divisions each of not more than 15 players; the Promoter may, with the consent of the Contest Supervisor, elect that the players placed 1st, 2nd and 3rd in each Division play off for placings in the section.
- D.1.03.04 If fewer than four players enter for a section, the Promoter may, with the consent of the Contest Supervisor, cancel the section. If the section proceeds and the judge considers that the standard does not justify awarding three places the judge shall so notify the Contest Supervisor, and only that number of places, if any, which the judge recommends shall be awarded and prizes awarded accordingly.
- D.1.03.05 No entry for a section shall be accepted after the draw therefor has commenced unless the Contest Supervisor chooses to accept the late entry. No such entry shall be accepted after the first player in the last Division of the section has commenced to play.

- D.1.03.06 Players shall be called upon to play in the order drawn pursuant to this Rule, but the Contest Supervisor may vary the draw for apparent reason or on the application of a player.
- D.1.03.07 A player not appearing within one minute of being called, or not commencing within two minutes of being called (otherwise than at the direction of the judge not to commence) shall be disqualified.

D.1.04 MUSIC

- D.1.04.01 The music for each section at a contest shall be specified by the Association.
- D.1.04.02 The music shall be played through the number of times specified, and if there is no specification, once through only.
- D.1.04.03 A player not complying with the specification of the music and with this Rule shall be disqualified.

D.1.05 POINTS ALLOTTED

- D.1.05 In all solo piping and drumming contests the maximum points allotted shall be 100.

D.1.06 SPECIAL PROVISIONS

- D.1.06.01 A player in a Learner Grade contest shall play a bagpipe or a drum.
- D.1.06.02 A Learner piper shall play only simple time tunes.
- D.1.06.03 A Learner drummer shall play only simple time scores as set out in the Federation Drumming Manual.
- D.1.06.04 A drummer may be accompanied by one or two pipers only who shall play in the traditional manner. A tenor or bass drummer may also be accompanied by one snare drummer.
- D.1.06.05 A drummer shall commence with two three-pace rolls except for a Slow Air which shall commence with an introduction of the player's own choice.

D.1.07 AGGREGATE CONTESTS

- D.1.07.01 In any aggregate contest, points shall be awarded (subject to Rule D.1.03.04) thus:-
 - (1) To the player placed 1st - 5 points
 - (2) To the player placed 2nd - 3 points
 - (3) To the player placed 3rd - 1 point;

provided that if there be a tie for a place between two players for 1st and 2nd, each player shall be awarded 4 points, and between two players for 2nd and 3rd, each player shall be awarded 2 points, between two players for 3rd, each player shall be awarded 0.5 points; between three or more players for any place the points for that place and any lesser place shall be divided equally between those players.

To be eligible for a place in an aggregate contest based on the results of a number of contests a competitor must compete in at least 50% of the contests held.
- D.1.07.02 Where there is a tie for an aggregate place conducted at a number of contests an apparent tie shall be split by reference to 1st placings, second by reference to 2nd placings and third by reference to 3rd placings. If this does not split an apparent tie the competitors shall be required to play off at the final contest comprising the aggregate contest. The absence of a player at the final contest means that player forfeits the placing. The music to be played shall be from the program for the last contest on which

the aggregate contest is based except for Open Grade drumming where a March, Strathspey and Reel of 4 or more parts shall apply.

D.1.08 DRESS

D.1.08.01 In solo contests and the presentation of trophies, therefor, a player shall wear approved band uniform or highland or other appropriate dress to the satisfaction of the contest supervisor.

D.1.08.02 A player (s) accompanying a drummer, under Rule D.1.06.04, shall wear approved band uniform or highland dress or other appropriate dress to the satisfaction of the contest supervisor.

D.1.09 JUDGING

D.1.09.01 Judging of piping and drumming shall commence on the player being directed by the judge to proceed, and shall cease on the last note played.

D.1.09.02 A player shall not be penalised for the setting of the music played, provided that Rule D.1.06 is complied with.

D.1.10 MOVEMENT OF PLAYERS

D.1.10.01 A player shall move to and from a tuning area and the prescribed contest point as directed by the officials.

D.1.10.02 The Contest Supervisor may define the boundaries of the prescribed contest point or points and of one or more tuning areas, and may also define silent areas adjacent thereto. Such boundaries shall be notified by notice at such place as the Contest Supervisor considers appropriate. A player shall not tune or play an instrument in a silent area except with the express prior permission of the Contest Supervisor. Except while competing or accompanying a drummer in accordance with these Rules, a player shall not tune or play an instrument at or in the immediate vicinity of a contest point otherwise than during the period of two minutes from being called pursuant to Rule C.1.03 or by express permission of the judge or the Contest Supervisor.

D.1.11 CONTACT BETWEEN JUDGES AND PLAYERS

D.1.11.01 A player shall not initiate any contact with a judge during the conduct of a section.

D.1.12 ENTRIES FROM REGISTERED PLAYERS ONLY

D.1.12.01 Entries for solo piping and drumming contests shall be accepted only from players currently registered as such by the Association and only for the grade determined by the Association in respect of each player and from players recognised by the Association as duly affiliated by virtue of registration with an affiliated overseas pipe band or piping or drumming association (however titled), and only for the grade determined in respect of each such player by the Association, provided that a Promoter with the consent of the Contest Supervisor may permit a player other than one graded Novice or Beginner to enter in the grade next above that grade, and provided further that the Association may authorise the acceptance of entries from players of specified or all grades for a particular event or contest.

D.1.12.02 A player shall not compete in a contest not registered with the Association under these Rules.

D.1.13 OFFICIALS

D.1.13.01 Rule A.1.06 applies.

D.1.13.02 The Promoter shall appoint, subject to the approval of the Association, the following:

- (1) Judges, as prescribed by these Rules, from the Association or Branch Panels of Judges;
- (2) Appropriate officials competent to carry out the duties necessary to give effect to these Rules.

D.1.13.03 Subject to the supervision of the Contest Supervisor, the officials shall be responsible for the orderly movement of players to and from the tuning area and contest point. Under the supervision of the Contest Supervisor, the officials shall check judging sheets, record the players' scores, and prepare the results of the contest.

D.1.13.04 [rescinded 1995]

D.1.14 JUDGES

D.1.14.01 At a contest at which there is a piping contest at least one piping judge shall be rostered and at a contest at which there is a drumming contest at least one drumming judge shall be rostered.

D.1.15 JUDGING SHEETS

D.1.15.01 The Association may provide judging sheets in respect of each competitor, in which case this Rule shall apply.

D.1.15.02 After judging each division or section, a judge shall pass the judging sheets to an official who shall enter the totals on the Master Sheet.

D.1.15.03 When all judging sheets relating to a division or section have been so checked and entered, the original sheets shall be available to the competitor, the duplicate copies (if any) being retained by the Association.

D.1.15.04 The results of a contest shall be provisional until the expiration of the time within which a protest may be lodged and the determination of any protest.

D.1.14.05 A judge who notices a breach of these Rules shall draw it to the attention of the Contest Supervisor and endorse on the judging sheet that a player has in a particular case breached these Rules.

[CHAPTER 2 - STAFF FLOURISH CONTESTS rescinded 1995]

CHAPTER 3 - GROUPS OF PIPERS

D.3.01 CONTEST

D.3.01.01 A Branch may sanction a promotor may hold any of the following contests, being a duo, trio, quartet and quintet contest.

D.3.02 COMPLIMENT

D.3.02.01 The complement of Members who make up a duo, trio, quartet and quintet shall be known as a group.

D.3.02.02 The complement of a duo shall be 2 pipers, or 2 snare drummers or 1 piper and 1 drummer.

D.3.02.03 The complement of a trio shall be 3 pipers, or 3 snare drummers or 2 pipers and 1 snare drummer.

D.3.02.04 The complement of a quartet shall be 4 pipers, or 4 snare drummers or 3 pipers and 1 snare drummer.

- D 3.02.05 The complement of a quintet shall be 3 pipers, 1 bass or tenor drummer and 1 snare drummer.
- D 3.02.06 Players of a group shall be Members of the Association and are not required to be registered with the same band.
- D 3.02.07 Players shall not compete with any other group within the same contest. This rule should not prevent a player competing with another group in a different contest on the same day.
- D 3.02.08 If a player of a group is unable to compete on the day of the contest, the Contest Supervisor may allow the substitution of that player by any other Member.
- D.3.03 DRESS**
- D 3.03.01 Each player of the group shall wear approved band uniform or Highland or other appropriate dress to the satisfaction of the Association. Each player is not required to wear the same dress as other players of the group.
- D.3.04 GRADING**
- D 3.04.01 The determination and application of grading is at the discretion of the Branch in consultation with the promoter.
- D.3.05 MUSIC**
- D 3.05.01 The music of any contest shall be one or any of the following:
- a. Any part of parts of an MSR up to the maximum requirement of Grade 4; or
 - b. A selection of marches or march up to the maximum requirement of Contest Regulations; or
 - c. A medley of own choice of between 3 and 7 minutes.
- D.3.06 JUDGES**
- D 3.06.01 The contest shall be adjudicated by 1 piping and 1 drumming judge, with the optional addition of an ensemble judge.
- D 3.06.02 If a contest consists of only one discipline, up to three judges of that discipline may adjudicate, at the discretion of the promoter.
- D.3.06 CONTEST OPERATION AND ADMINISTRATION**
- D 3.07.01 If necessary, the promoter shall determine and notify groups of:
- a. The draw;
 - b. Attendance of bands;
 - c. Contact between judges and players
 - d. Judging sheets;
 - e. Ties;
 - f. Officials;
 - g. Movement of bands; and
 - h. Aggregate contests.
- D 3.07.02 In the absence of any determination by the promoter, any of the above points shall be consistent with Part C of the Contest Regulations.

CHAPTER 4 - DRUM MAJOR'S CONTEST (SOLO)

D.4.01 DRUM MAJOR'S CONTEST (SOLO)

- D.4.01.01 This event shall be open to any person registered with the Association as a player for contest by a band or as a solo player or recognised by the Association as duly affiliated by virtue of registration with an overseas pipe band or piping or drumming association (however titled), in this Chapter called "player".
- D.4.01.02 A player shall wear approved band uniform or Highland or other dress to the satisfaction of the Association, and carry a mace which, when the ferrule is in contact with the ground, reaches at least to the top of the player's shoulder when standing at attention, or which is 1.35m in length, whichever length is the lesser.
- D.4.01.03 Should the number of entries exceed five, then there shall be sections each of not more than five players, and the five players gaining the highest points in the sections shall contest a final. When a final is conducted, there shall not be a further Dress Inspection, but each player shall be awarded the same number of points for Dress as in his original Dress Inspection.
- D.4.01.04 The course shall be marked by three flags, in a straight line, each 25m apart.
- D.4.01.05 Not less than two Dress & Drill judges shall be rostered.

D.4.02 POINTS ALLOTTED

D.4.02 The maximum points allotted shall be 100, thus:

(1) Dress	20
(2) Marching and Department	40
(3) Flourish	40

D.4.03 PROCEDURE

- D.4.03.01 The players shall report at the time prescribed by the Contest Supervisor, for Dress Inspection, which shall be carried out at a convenient location.
- D.4.03.02 When directed by the judge or official, the players shall move to the start line, halt and stand at ease.
- D.4.03.03 Judging (other than for Dress) shall commence when the judge directs the players to come to attention: they shall then do so.
- D.4.03.04 The judge shall ensure that the duty band is ready, and on the order the band will commence playing (in 6/8 time at a tempo of approximately 96 beats per minute) and the players will proceed to the far end of the course, there turning about, returning to the start line, turning about and marching to the centre of the course (in line with the second flag) where they will mark time until the end of the part of music being played, then halt and give a mace signal to the band to cease playing, at the end of that part.
- D.4.03.05 On approaching each turn point, a player shall give a mace signal to signify the approaching turn, and, at the point, turn about.
- D.4.03.06 On approaching the halt point, a player shall give a mace signal in preparation to halting, mark time in line with the flag until the end of the part of the music then being played, halt, and give a "Cease playing" signal during the next double forte part.
- D.4.03.07 When all players have completed this procedure the judge shall direct the duty band to cease playing, and the players to stand at ease, which they shall do, whereupon judging shall cease. The players shall stand fast until dismissed by the judge.

D.4.04 POINTS AWARDED

- D.4.04.01 Marching and Deportment - Points shall be awarded for movement and control of the "free" arm, when marching, the movement and control of the "mace" arm when marching, and execution of the "walk" when performed, for erectness of body, general bearing, and maintenance of "eye-line", for the smartness of performance of coming to attention, stepping off marching, about turns, marking time, halting, standing at ease at the end of the competition, for about turn signal, mark time signal, halt signal, cease playing signal.
- D.4.04.02 Flourish - Points shall be awarded for variety of flourish taking account of the differing flourishes performed by the player (the greater the variety of flourishes performed the greater the score), for the fluency with which the flourishes are performed, the confidence which the player displays whilst flourishing and the level of accuracy attained during the flourishes, for degree of difficulty taking account of the general level of difficulty of the individual flourishes performed (the harder the flourishes the greater the score.)

D.4.05 PENALTIES

- D.4.05.01 A player shall not flourish during a piano part of the music: if the ferrule of the mace rises above its head during a piano forte part four points shall be deducted from the points allotted to the player for Quality of Flourish for each such occurrence.
- D.4.05.02 A player who drops the mace shall lose 2 points from the points allotted for Quality of Flourish, and not less than two nor more than five points from the points allotted for Deportment, depending on how much deportment is lost recovering the mace.
- D.4.05.03 A player who gives the signal to cease playing during a piano forte part of the music being played shall lose two points from the points allotted for Mace Drill.
- D.4.05.04 One point shall be deducted from the points allotted for Dress for each fault found in dress.
- D.4.05.05 One point shall be deducted for each measure of music during which a player remains out of step with music being played by the duty band.

D.4.06 AGGREGATE CONTESTS

- D.4.06.01 In any aggregate contest, points shall be awarded thus: -
- (1) To the competitor placed 1st - 5 points
 - (2) To the competitor placed 2nd - 3 points
 - (3) To the competitor placed 3rd - 1 point;
- provided that if there be a tie for a place between two competitors for 1st and 2nd, each competitor shall be awarded 4 points, and between two competitors for 2nd and 3rd, each competitor shall be awarded 2 points, between two competitors for 3rd place each competitor shall be awarded 0.5 points; between three or more competitors for any place the points for that place and any lesser place shall be divided equally between those competitors.
- To be eligible for a place in an aggregate contest based on the results of a number of contests a competitor must compete in at least 50% of the contests held.
- D.4.06.02 Where there is a tie for any aggregate place conducted at a number of contests an apparent tie shall be split by reference to 1st placings, second by reference to 2nd placings and third by reference to 3rd placings. If this reference does not split an

apparent tie the placings at the final contest comprising the aggregate for the competitor(s) concerned shall determine the result and if this does not separate the competitors the result shall be a tie.

The absence of a competitor at the final contest may mean he / she forfeits the placing.

PART E - PROMOTION OF CONTESTS

CHAPTER 1 - GENERAL

E.1.01 REGISTRATION OF CONTESTS

- E.1.01.01 A Promoter desiring to conduct any contest under these Rules shall apply to the Association for registration of the contest at least three months before its proposed date, and at least six months beforehand in the case of State or Branch Pipe Band Championships.
- E.1.01.02 The application shall be in writing, and shall include particulars of the proposed programme, prizes and travelling or appearance money offered, and shall be accompanied by the fee from time to time fixed by the Association, which shall be refunded if the application is not granted.

E.1.02 ACCEPTANCE OF ENTRIES

- E.1.02.01 Rule A.3.05 applies in relation to entries for band or miniature band contests.
- E.1.02.02 Rule D.1.12 applies in relation to entries for solo piping or drumming contests.
- E.1.02.03 Rule D.2.1.01 applies to entries for a Flourish contest.

E.1.03 FACILITIES TO BE SUPPLIED

- E.1.03.01 If entries for solo contests are taken on the day of a contest, the Promoter shall make arrangements to the satisfaction of the Contest Supervisor for the taking of entries. No entry shall be accepted unless the entrant produces evidence of current registration under these Rules.
- E.1.03.02 The Promoter shall provide not less than four officials to carry out the duties allotted under these Rules including the checking of judging sheets, scoring and preparation of results of the contest, and movement of bands and players.

[NOTE: Rules B.1.06, B.1.08, B.1.10, B.1.15, C.1.06, C.1.08, C.1.13, D.1.03, D.1.10 and D.1.13 apply.]

- E.1.03.03 Suitable seating, writing and refreshment arrangements to the satisfaction of the Contest Supervisor shall be provided by the Promoter for the judges, officials and Contest Supervisor.
- E.1.03.04 A Promoter shall pay to each judge officiating at the contest the fee from time to time prescribed by the Association, and the appropriate rail or air fare and such accommodation, meal and like expenses of an appropriate standard as are necessitated by the judge's attendance at the contest.

E.1.04 MASSED BANDS

- E.1.04 Massed Band arrangements at any contest shall be subject to the prior approval of the Association, and, on the day, of the Contest Supervisor, and such directions may be given in relation thereto by the Association or the Contest Supervisor as are thought appropriate.

E.1.05 PRIZE MONEY

- E.1.05 A Promoter shall pay prize money as advertised to bands placed in any contest, even if fewer bands compete than there are prizes advertised, except that a prize need not be paid to a band competing out of its allocated grade unless it is placed ahead of a band allocated to the grade contested.

CHAPTER 2 - CONTEST FORMAT AND GROUND LAYOUT

E.2.01 GROUND LAYOUT

- E.2.01.01 Rule B.2.04 applies to the course for the Quickstep.
- E.2.01.02 Rule B.3.03 applies to the course for the March Strathspey and Reel / Selection of Marches.
- E.2.01.03 Rule B.4.03 applies to the course for the Medley.
- E.2.01.04 Rule B.5.01.01 applies to the arena for the Display.
- E.2.01.05 Rule B.7.01.01 applies to the course for the Street March.
- E.2.01.06 (Rescinded 1995)

E.2.02 DRAW

- E.2.02.01 Rule B.1.05 applies to the draw for order of play at a band contest.
- E.2.02.02 Rule C.1.05 applies to the draw for order of play at a miniature band contest.
- E.2.02.03 Rule D.1.03 applies to the draw for order of play at a solo contest.
- E.2.02.04 (Rescinded 1995)

Confirmation of Association/Branch responsibilities – Rule A.1.12

Pursuant to Rule A.1.12.03 of the Contest Rules, Council at the 1999 Conference meeting determined that the following references in the Contest Rules to "the Association" shall be taken to be references to the appropriate Branch of the Association:

Rule:	Brief description:	Conditions (if any)
• A.1.04.01	Penalties – breaches cognisable	
• A.1.08.02	Behaviour – referral of breach	
• A.3.02.02	Clearance – appeal when not given by band	
• A.3.05.05	Contest registration	
• B.1.01.02, .03	Elements in contest	
• B.1.04.01	Approval of uniform	
• B.1.05.01, .03	Contest Draw	
• B.1.08.01, .02, .03	Provision of Judging Sheets	
• B.1.10.02	Rostering of Judges for contest	
• B.1.11.04	Judges' duties	
• B.5.01	Display – grades for contest	
• B.6.01.01	When Dress Inspected	
• B.7.01, .03	Street March judging	
• B.8.01.01	Whether Drum Major (Quickstep) Contest	
• C.1.08.01	Miniature Band – Judging Sheets	
• C.1.10.02	Miniature Band – Rostering of Judges	
• C.2.01.01	Miniature Band – test music	
• D.1.02	Solo - Registration	
• D.1.03	Solo – Entry arrangements	
• D.1.12.01	Solo – Entries, multiple graded contests	See footnote ¹
• D.1.13.01	Solo – Rostering of judges	
• D.1.15.01, .03	Solo – Judging sheets	
• D.3.01	Groups of Pipers – number	See footnote ²
• D.3.03	Groups of Pipers – grading	See footnote ³
• D.4.01.02	Drum Major (Solo) – uniform	
• E.1.01.01	Promotion – registration of contests	
• E.1.03.04	Promotion – Fixing Judge's fee	
• E.1.04	Promotion – Massed Band arrangements	

and the following references shall be taken to be references to the Association and not to a Branch:

Rule	Brief description	Conditions (if any)
• A.1.03.02	Local and minor conditions, special entry ...	See footnote ⁴
• Part A Chapter 3	Registration	Except A.3.02
• D.1.12.01	Solo – Registration of solo players	See footnote ⁵
• D.4.01.01	Drum Major (Solo) – registration	

¹ Provided that any exercise of the discretion "to authorise the acceptance of entries from players of specified or all grades for a particular event or contest" is promptly notified to the Association and to all other Branches.

² Provided that the Association and all other Branches are promptly notified. And see footnote 3 and 5.

³ See footnote 5: grading is by Branch, based on the band and solo gradings of the players.

⁴ Provided that the Committee will not unreasonably refuse to establish local and minor conditions and special conditions of entry on the prior request of a Branch.

⁵ Solo registration is to be as prescribed by the Association though remaining in the hands of the Branches for administration at present, provided that lists of currently registered players are supplied to the Association as requested and at least annually. Grading of solo players remains with the Branches at present. The other matters referred to in the Rule are delegated to the Branches.